

-25 kg

2 Judoka

BEST OF THREE

1	MCCOY, Avie	WA	1	CYBULSKI, Peyton	QLD	00 / 01	3:00
2	CYBULSKI, Peyton	QLD					

1	MCCOY, Avie	WA	2	MCCOY, Avie	WA	10 / 01	0:53
2	CYBULSKI, Peyton	QLD					

1	MCCOY, Avie	WA	3	CYBULSKI, Peyton	QLD	00 / 10	0:41
2	CYBULSKI, Peyton	QLD					

Final Results

1. CYBULSKI, Peyton QLD
2. MCCOY, Avie WA

2022 Junior Boys and Girls Australian National Championships

Gold Coast (AUS), 11 Jun 2022

-29 kg

3 Judoka

			1	2	3	Wins Score	
1	NASSAR, Tailya	VIC		1	1	2 0	
2	WATKINS, Sienna	ACT	0		1	1 0	
3	ROBERTSON, Annemieke	NSW	0	0		0 0	

1	NASSAR, Tailya	VIC	1	NASSAR, Tailya		VIC
2	WATKINS, Sienna	ACT		10 / 00 s1	2:43	

1	NASSAR, Tailya	VIC	2	NASSAR, Tailya		VIC
3	ROBERTSON, Annemieke	NSW		10 / 00	2:57	

2	WATKINS, Sienna	ACT	3	WATKINS, Sienna		ACT
3	ROBERTSON, Annemieke	NSW		11 / 00 s1	2:49	

Final Results

- NASSAR, Tailya VIC
- WATKINS, Sienna ACT
-

2022 Junior Boys and Girls Australian National Championships

Gold Coast (AUS), 11 Jun 2022

-32 kg

10 Judoka

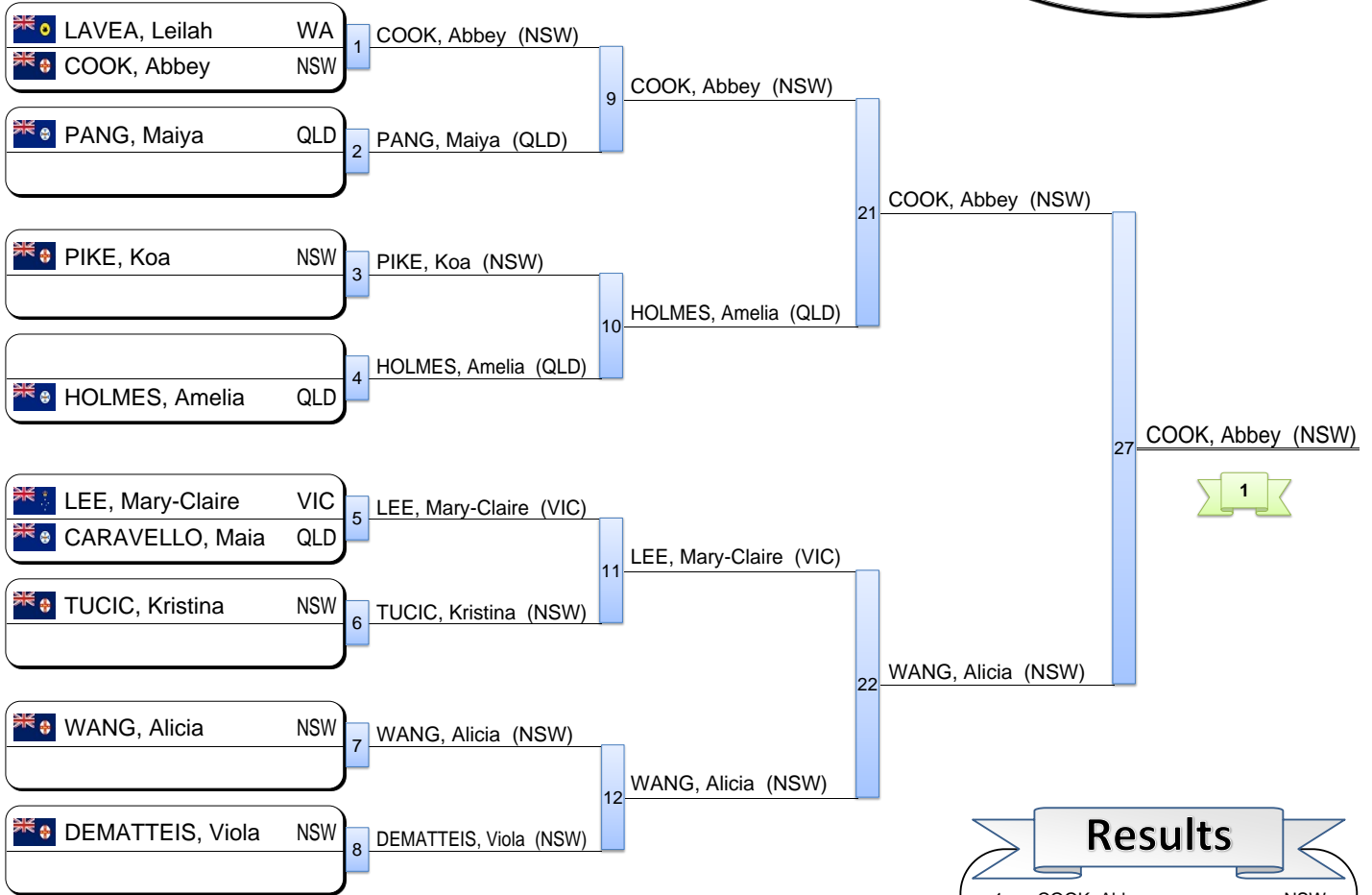

Results

1. COOK, Abbey NSW
2. WANG, Alicia NSW
3. LAVEA, Leilah WA
3. DEMATTEIS, Viola NSW
5. LEE, Mary-Claire VIC
5. HOLMES, Amelia QLD
7. PANG, Maiya QLD
7. TUCIC, Kristina NSW

Repechage

Loser contest **x** will appear at **x** in repechage

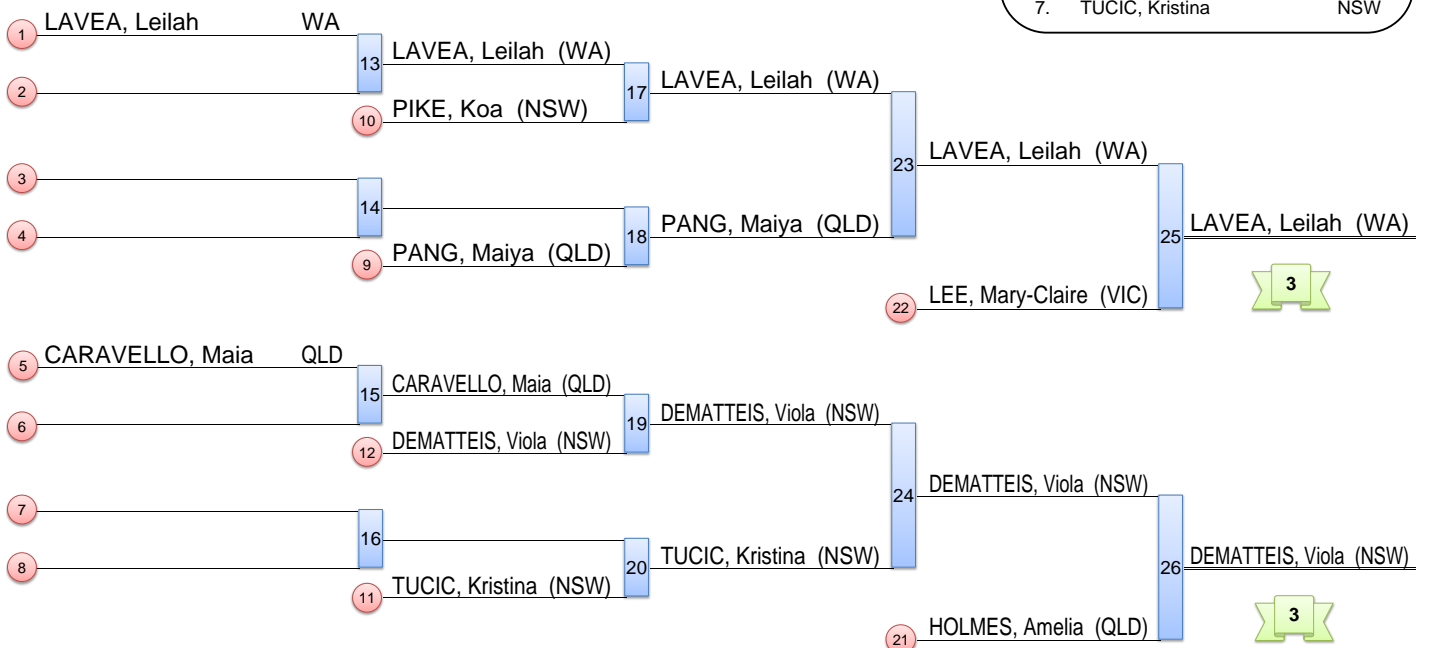

2022 Junior Boys and Girls Australian National Championships

Gold Coast (AUS), 11 Jun 2022

-36 kg

5 Judoka

	1	3	5	Wins Score	
1 HAYES, Macey TAS		1	0	1 0	
3 OCHI, Sakura WA	0		0	0 0	
5 TRAINOR, Amelia NSW	1	1		2 0	

	2	4	Wins	Scores
2 SIBONI, Mia WA		1		(0)
4 PLATONOV, Diana NSW	0			(0)

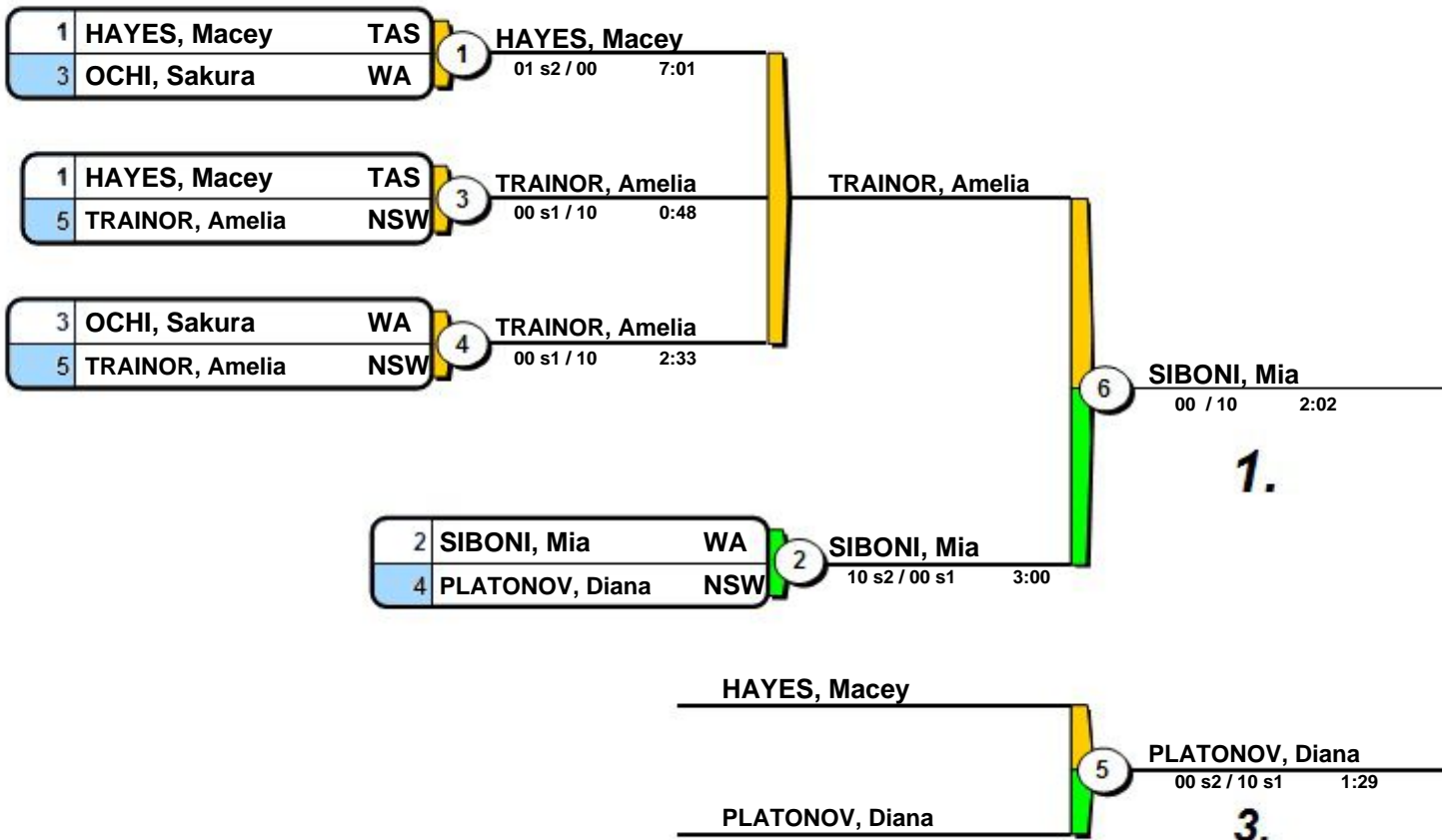

Final Results

1. SIBONI, Mia WA
2. TRAINOR, Amelia NSW
3. PLATONOV, Diana NSW

2022 Junior Boys and Girls Australian National Championships

Gold Coast (AUS), 11 Jun 2022

-40 kg

6 Judoka

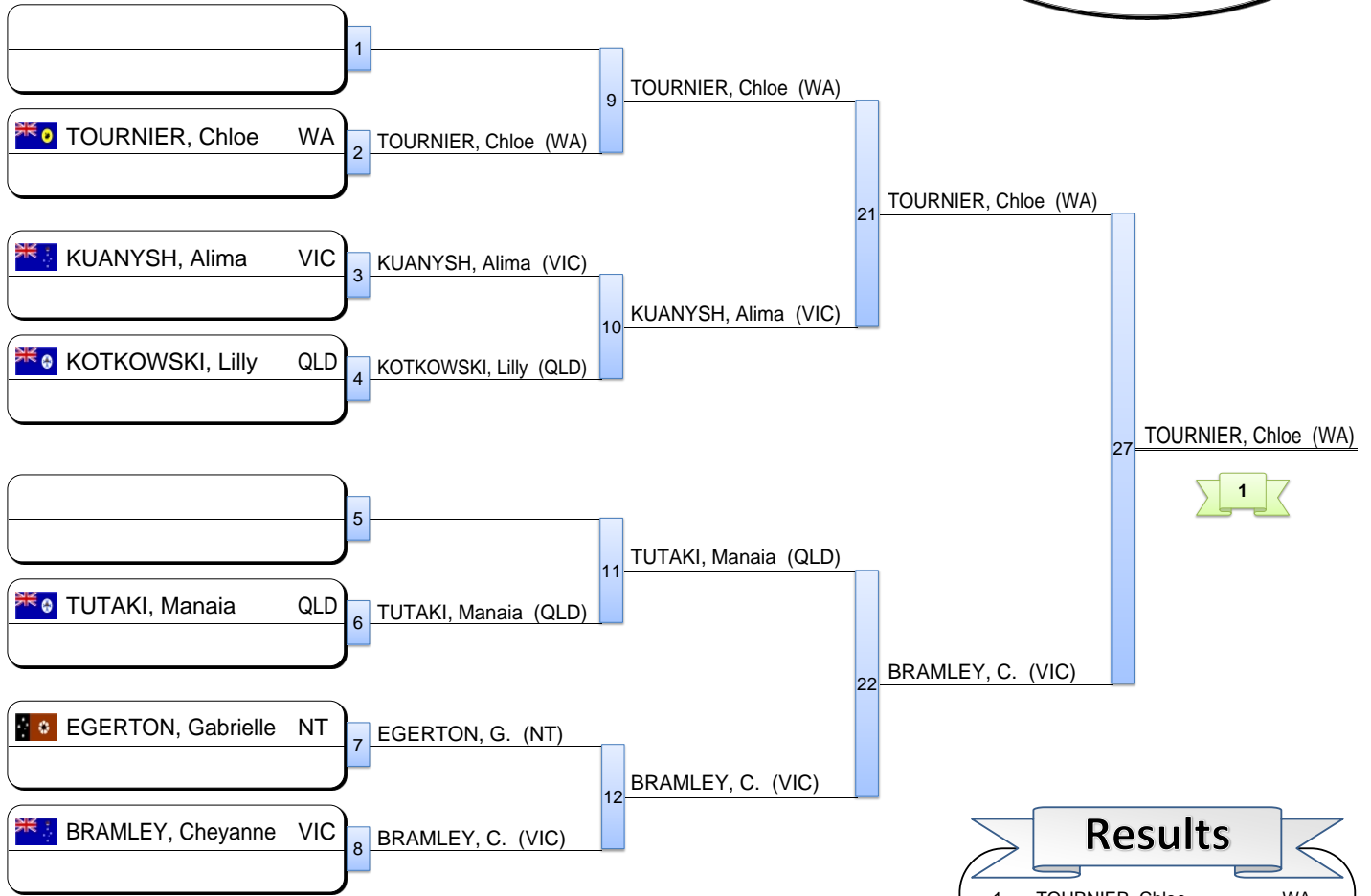

Results

1. TOURNIER, Chloe WA
2. BRAMLEY, Cheyanne VIC
3. KOTKOWSKI, Lilly QLD
3. KUANYSH, Alima VIC
5. TUTAKI, Manaia QLD
5. EGERTON, Gabrielle NT
- 7.
- 7.

Repechage

Loser contest **x** will appear at **x** in repechage

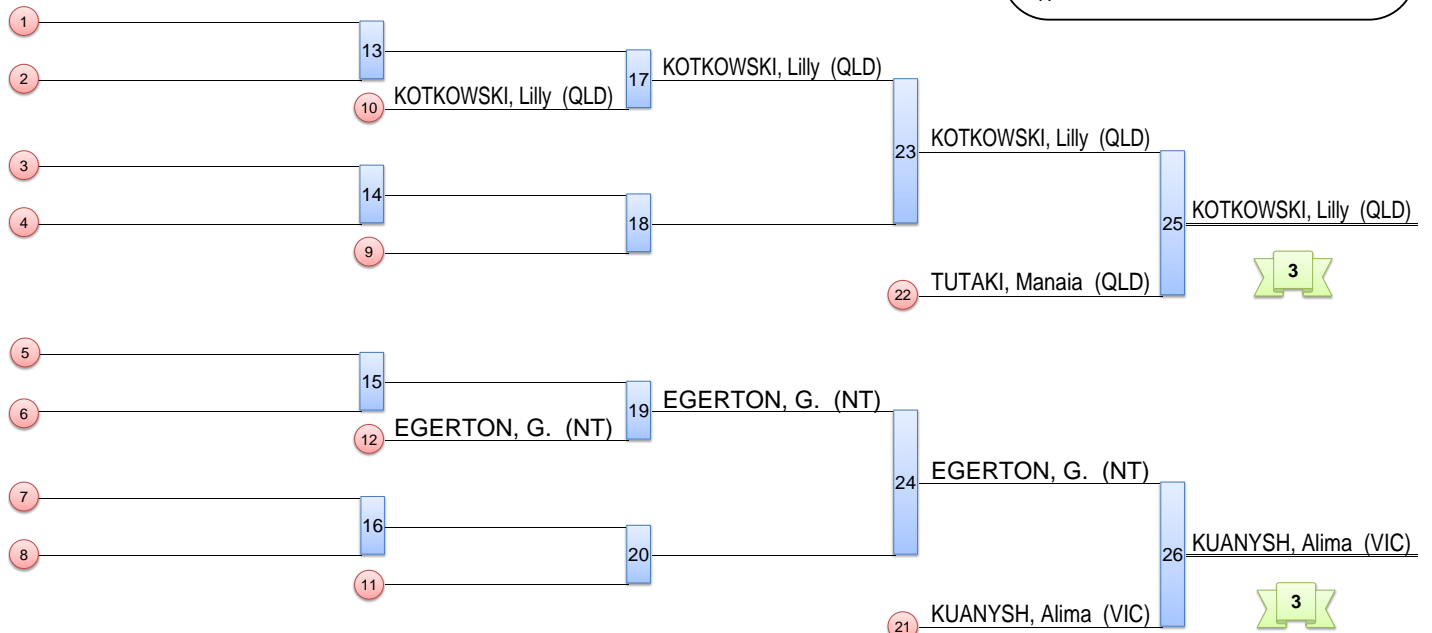

2022 Junior Boys and Girls Australian National Championships

Gold Coast (AUS), 11 Jun 2022

-44 kg

3 Judoka

			1	2	3	Wins Score	
1	RUTTAN, Moana	QLD		1	0	1 0	
2	DMITRENKO, Emily	QLD	0		0	0 0	
3	TOUBIA, Mariah	NSW	1	1		2 0	

1	RUTTAN, Moana	QLD	1	RUTTAN, Moana	QLD
2	DMITRENKO, Emily	QLD		10 / 00 s3	1:51

1	RUTTAN, Moana	QLD	2	TOUBIA, Mariah	NSW
3	TOUBIA, Mariah	NSW		00 / 10	1:34

2	DMITRENKO, Emily	QLD	3	TOUBIA, Mariah	NSW
3	TOUBIA, Mariah	NSW		00 s2 / 10 s1	2:15

Final Results

- TOUBIA, Mariah NSW
- RUTTAN, Moana QLD
-

2022 Junior Boys and Girls Australian National Championships

Gold Coast (AUS), 11 Jun 2022

-48 kg

3 Judoka

			1	2	3	Wins Score	
1	MUIR, Alana	ACT		0	0	0 0	
2	KUFALOVSKI, Mila	WA	1		0	1 0	
3	READ, Claudia	QLD	1	1		2 0	

1	MUIR, Alana	ACT	1	KUFALOVSKI, Mila	WA	00 / 10	0:10
2	KUFALOVSKI, Mila	WA					

1	MUIR, Alana	ACT	2	READ, Claudia	QLD	01 / 10	1:27
3	READ, Claudia	QLD					

2	KUFALOVSKI, Mila	WA	3	READ, Claudia	QLD	00 / 10	1:32
3	READ, Claudia	QLD					

Final Results

1. READ, Claudia QLD
2. KUFALOVSKI, Mila WA
- 3.

2022 Junior Boys and Girls Australian National Championships

Gold Coast (AUS), 11 Jun 2022

-52 kg

4 Judoka

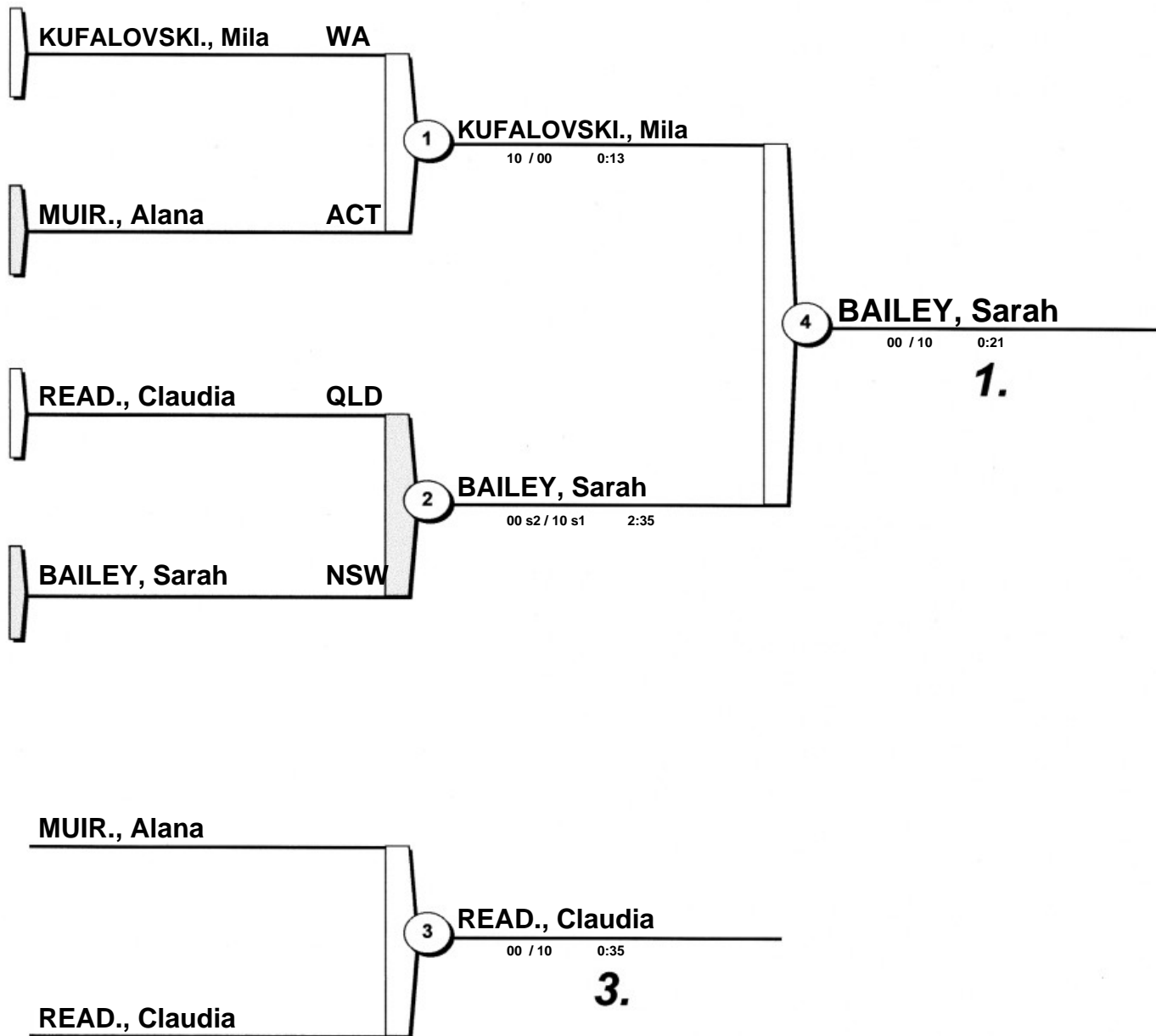

Final Results

- | | |
|----------------------|-----|
| 1. BAILEY, Sarah | NSW |
| 2. KUFALOVSKI., Mila | WA |
| 3. READ., Claudia | QLD |

2022 Junior Boys and Girls Australian National Championships

Gold Coast (AUS), 11 Jun 2022

+52 kg

5 Judoka

			1	3	5	Wins Score	
1	NAE, Kayla	WA		1	1	2 0	
3	LOWE, Faith Mary	NSW	0		0	0 0	
5	TUTAKI, Anahera	QLD	0	1		1 0	

			2	4	Wins	Scores
2	LETUFUGA, Micah	WA		1		(0)
4	ACASON, Eva	QLD	0			(0)

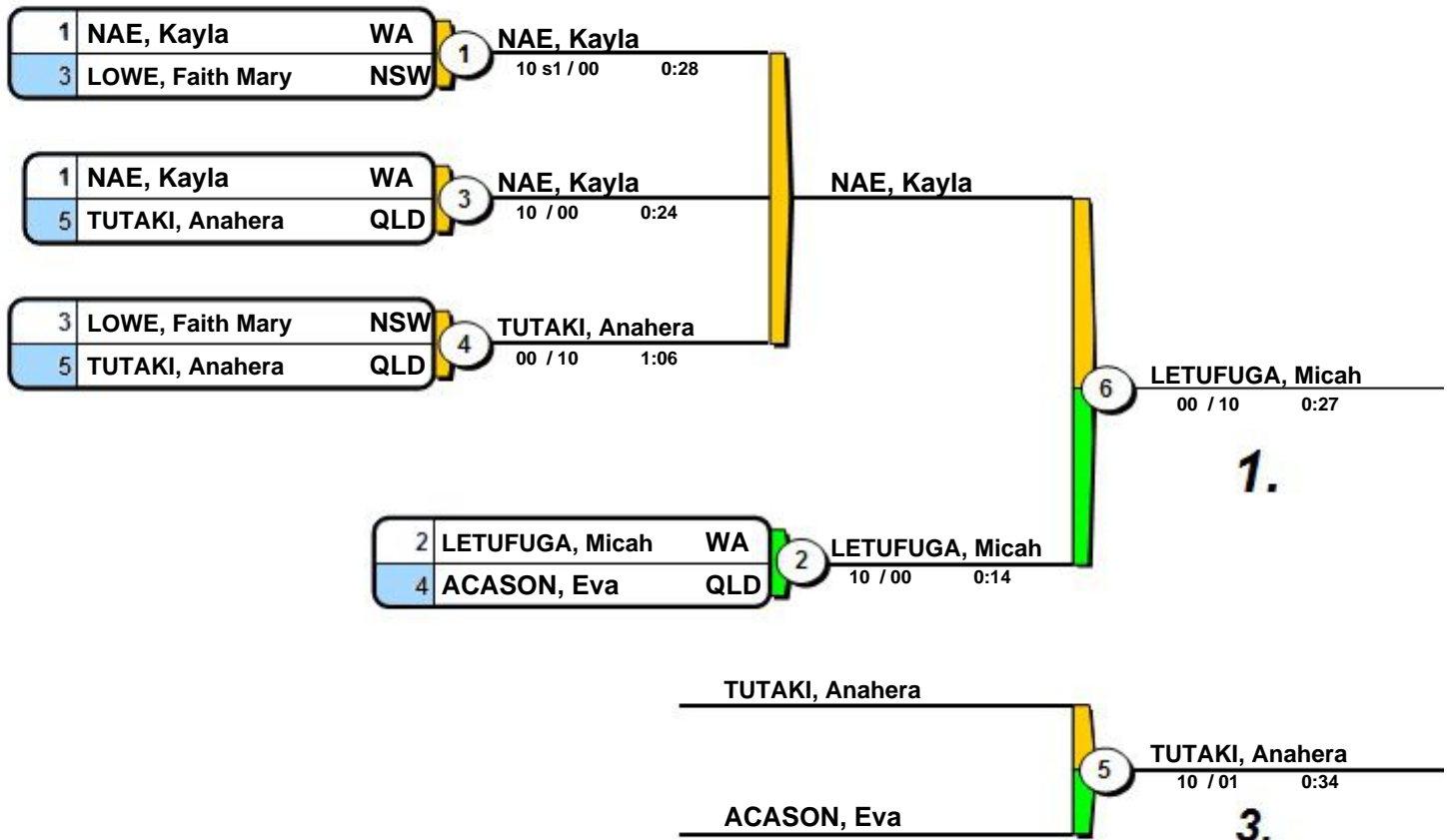

Final Results

- LETUFUGA, Micah WA
- NAE, Kayla WA
- TUTAKI, Anahera QLD

2022 Junior Boys and Girls Australian National Championships

Gold Coast (AUS), 11 Jun 2022

-27 kg

5 Judoka

			1	3	5	Wins Score	
1	SAKALOUSKI, Timofey	NSW		0	1	1 0	
3	MCCOY, Logan	WA	1		1	2 0	
5	PHOUPHAYLY, Riley	QLD	0	0		0 0	

			2	4	Wins	Scores
2	GAO, Stanley	NSW		0		(0)
4	ROTH, Cesare	WA	1			(0)

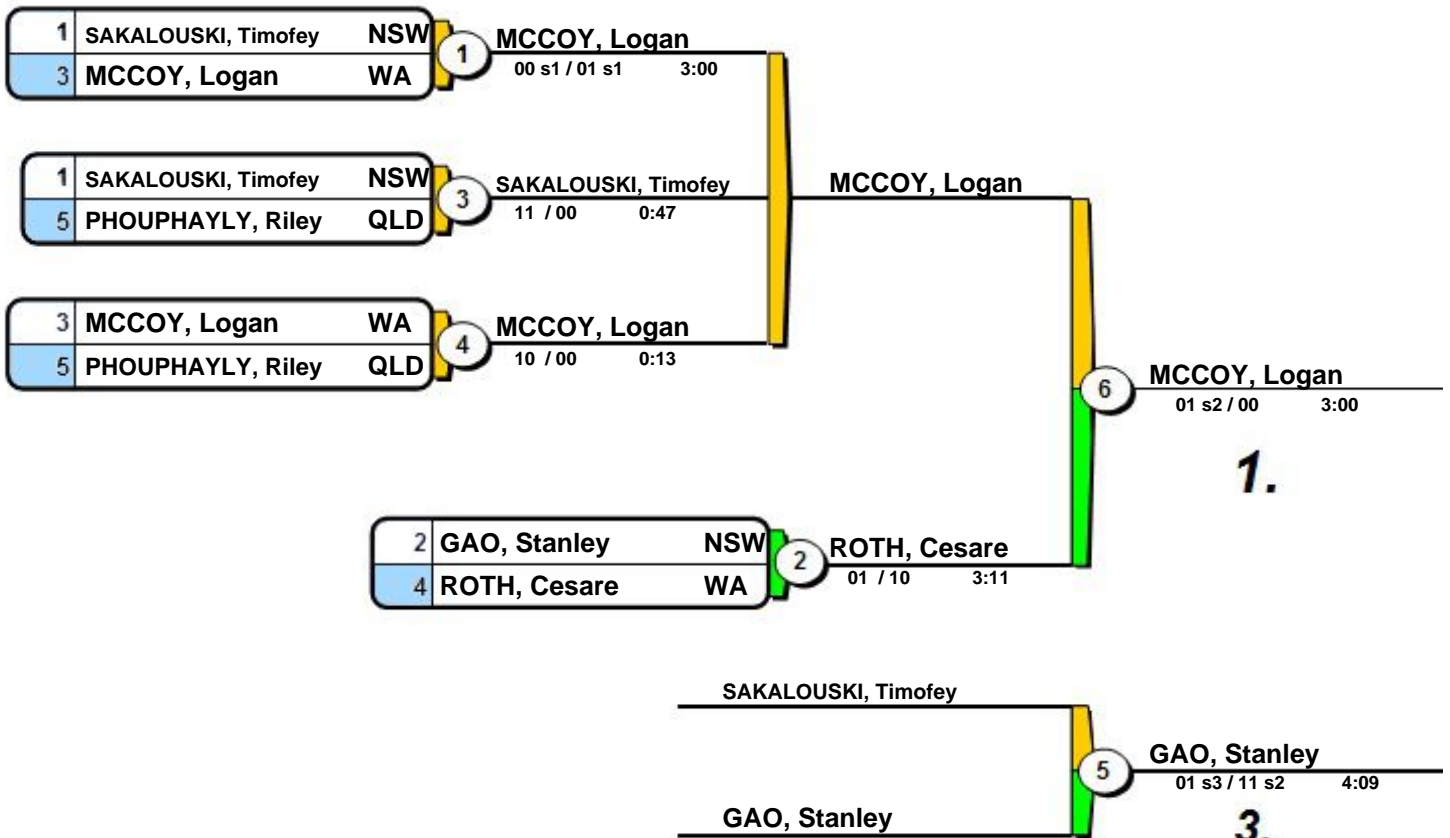

Final Results

1. MCCOY, Logan WA
2. ROTH, Cesare WA
3. GAO, Stanley NSW

2022 Junior Boys and Girls Australian National Championships

Gold Coast (AUS), 11 Jun 2022

-30 kg

11 Judoka

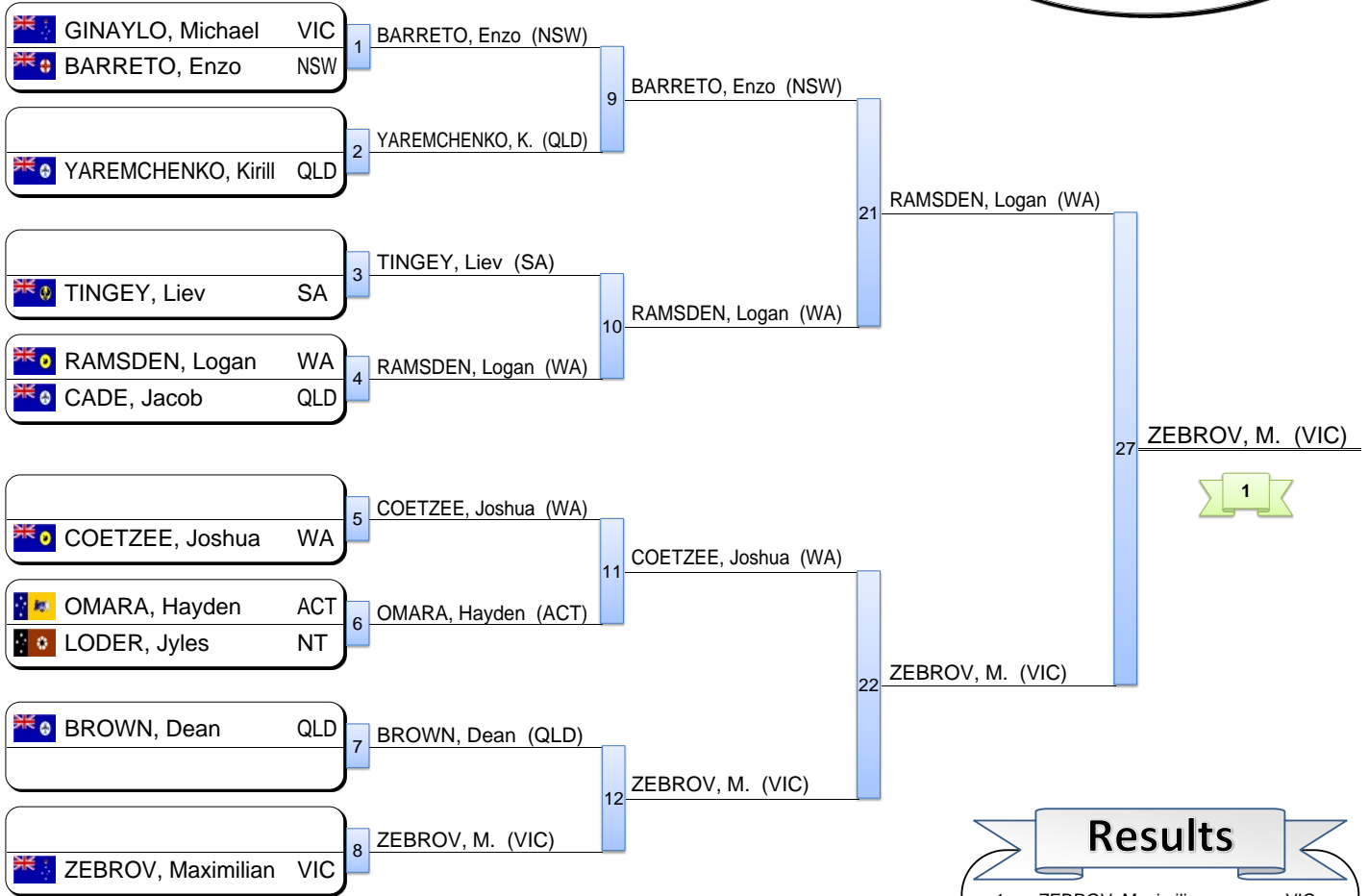

Repechage

Loser contest will appear at in repechage

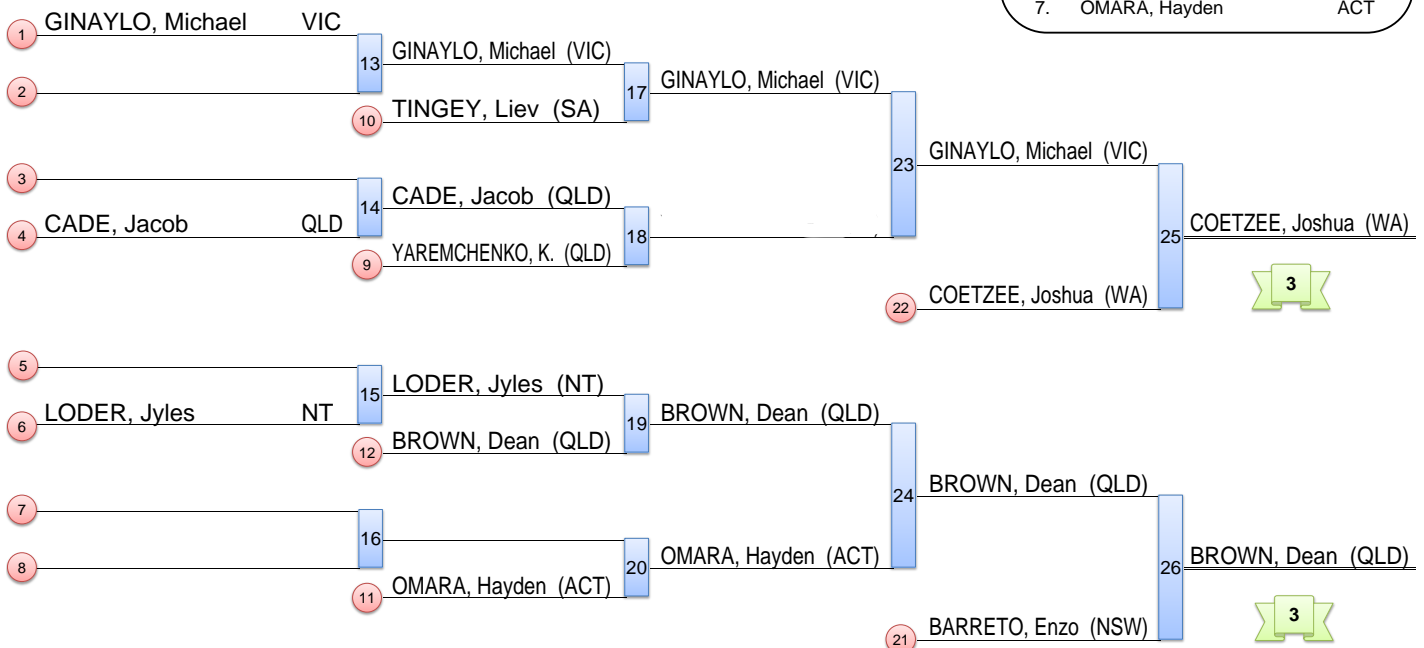

2022 Junior Boys and Girls Australian National Championships

Gold Coast (AUS), 11 Jun 2022

-34 kg

16 Judoka

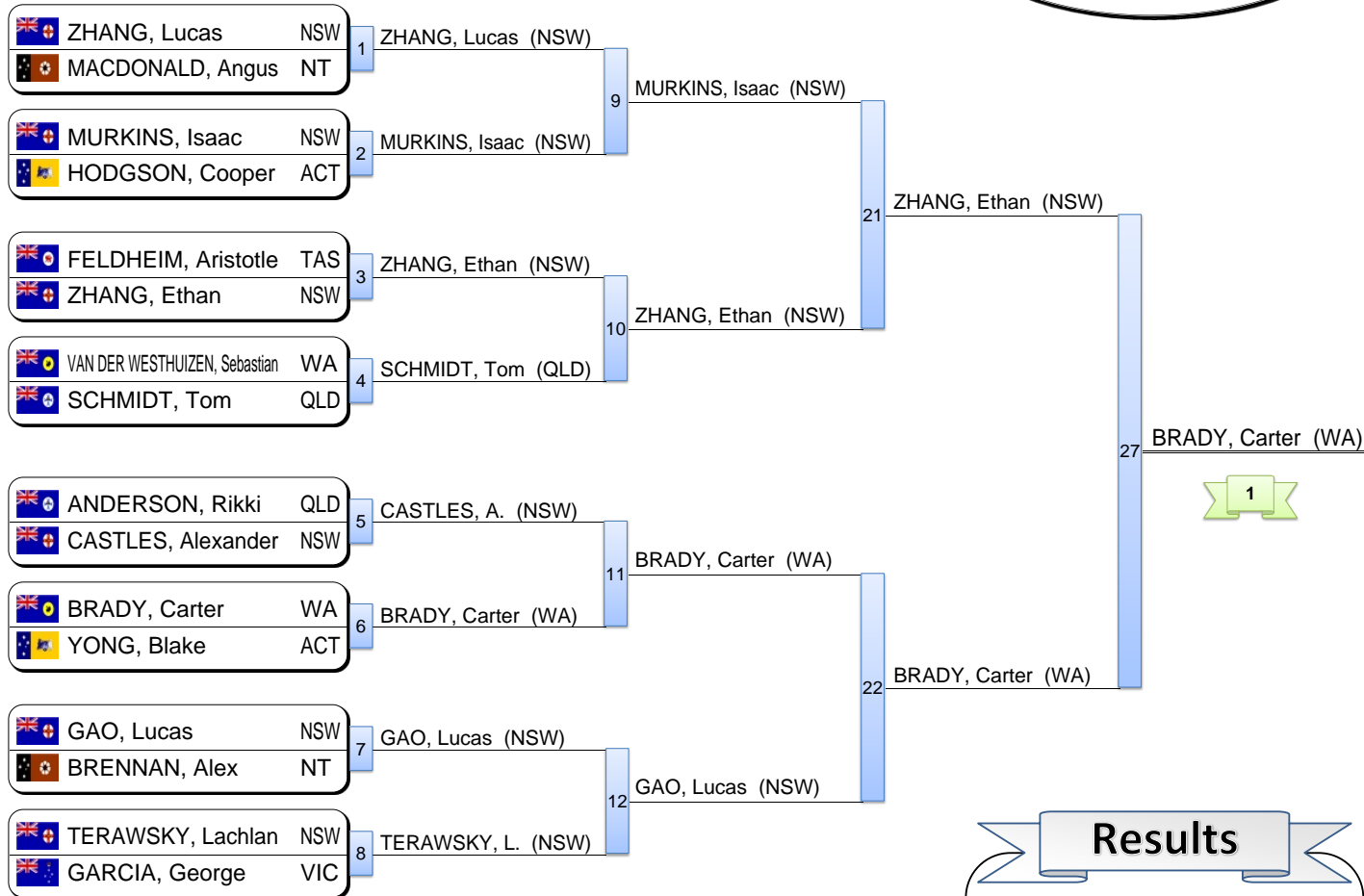

Results

- BRADY, Carter (WA)
- ZHANG, Ethan (NSW)
- GAO, Lucas (NSW)
- ANDERSON, Rikki (QLD)
- ZHANG, Lucas (NSW)
- MURKINS, Isaac (NSW)
- SCHMIDT, Tom (QLD)
- CASTLES, Alexander (NSW)

Repechage

Loser contest x will appear at x in repechage

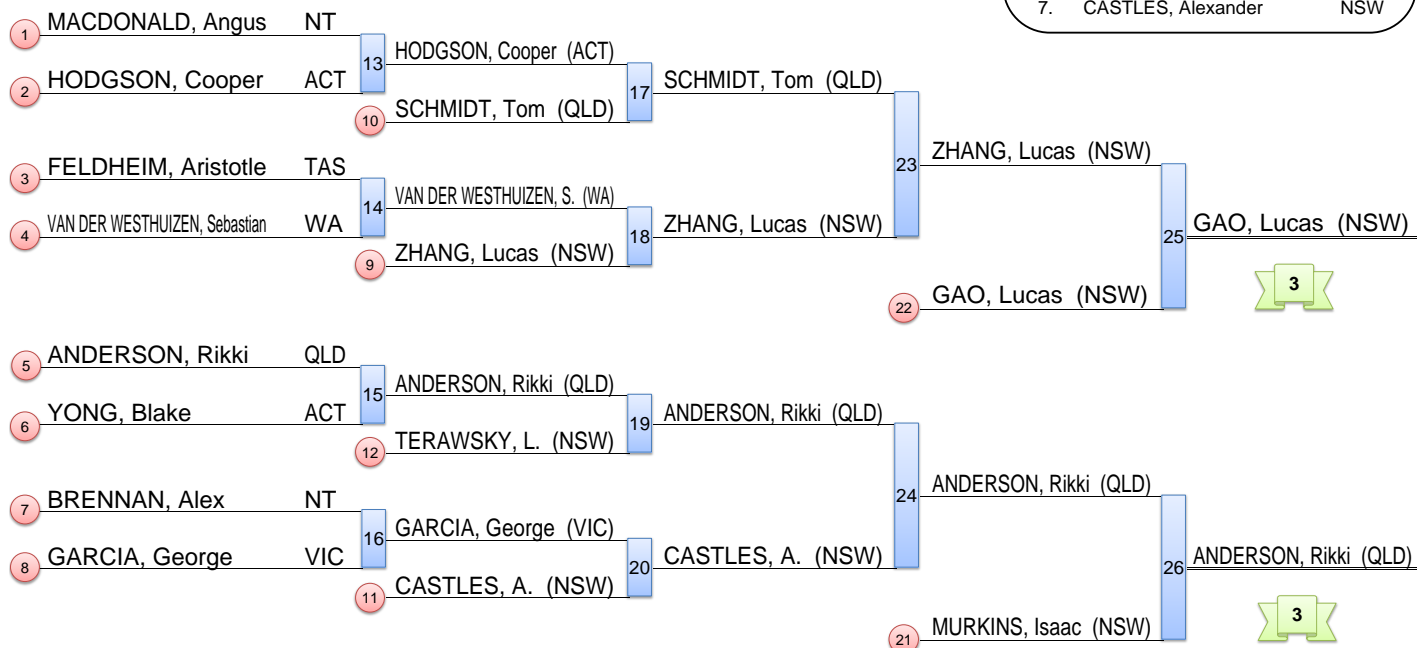

2022 Junior Boys and Girls Australian National Championships

Gold Coast (AUS), 11 Jun 2022

-38 kg

15 Judoka

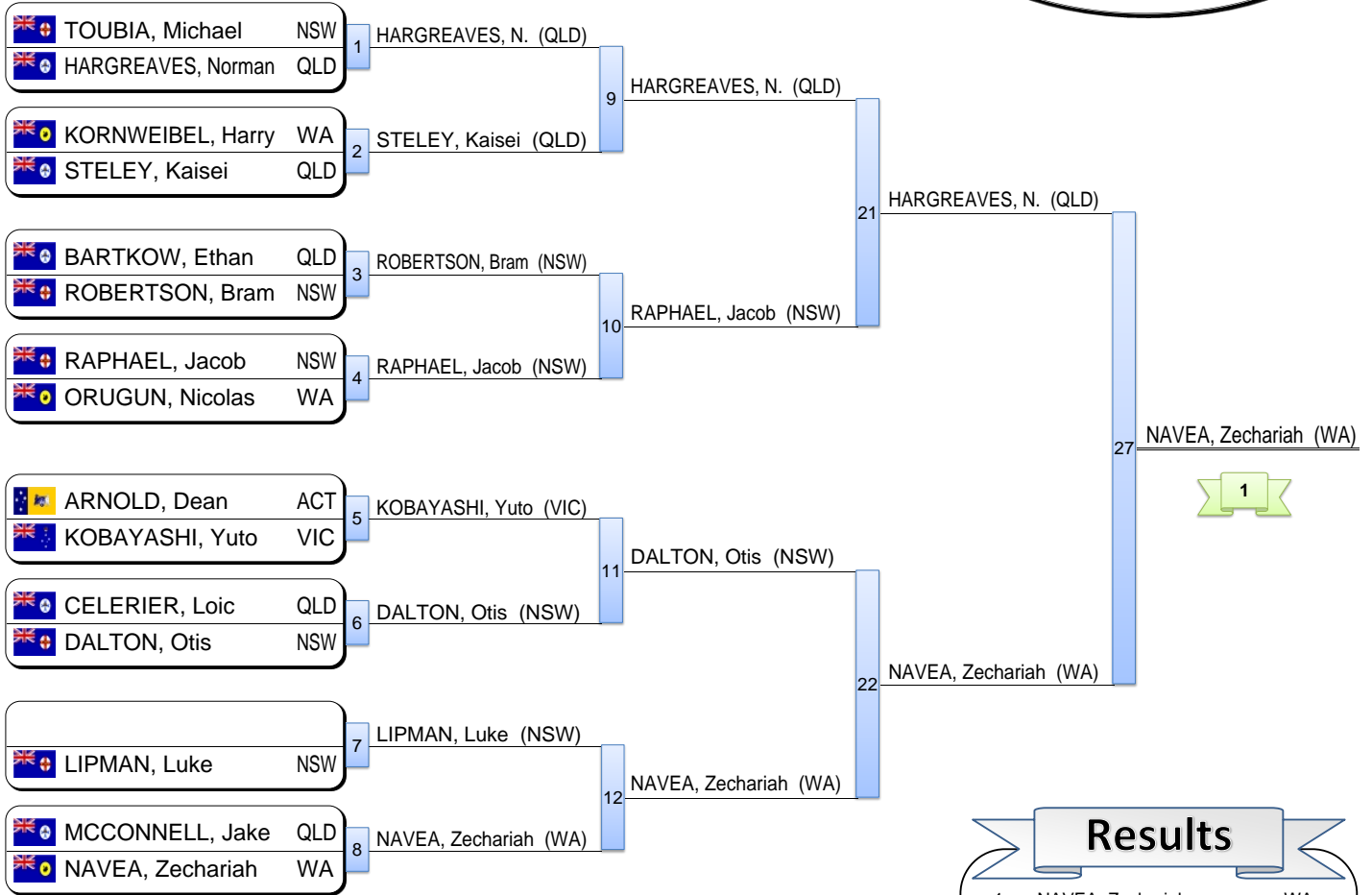

Results

1. NAVEA, Zechariah (WA)
2. HARGREAVES, Norman (QLD)
3. DALTON, Otis (NSW)
3. RAPHAEL, Jacob (NSW)
5. ORUGUN, Nicolas (WA)
5. CELERIER, Loic (QLD)
7. ROBERTSON, Bram (NSW)
7. KOBAYASHI, Yuto (VIC)

Repechage

Loser contest **x** will appear at **x** in repechage

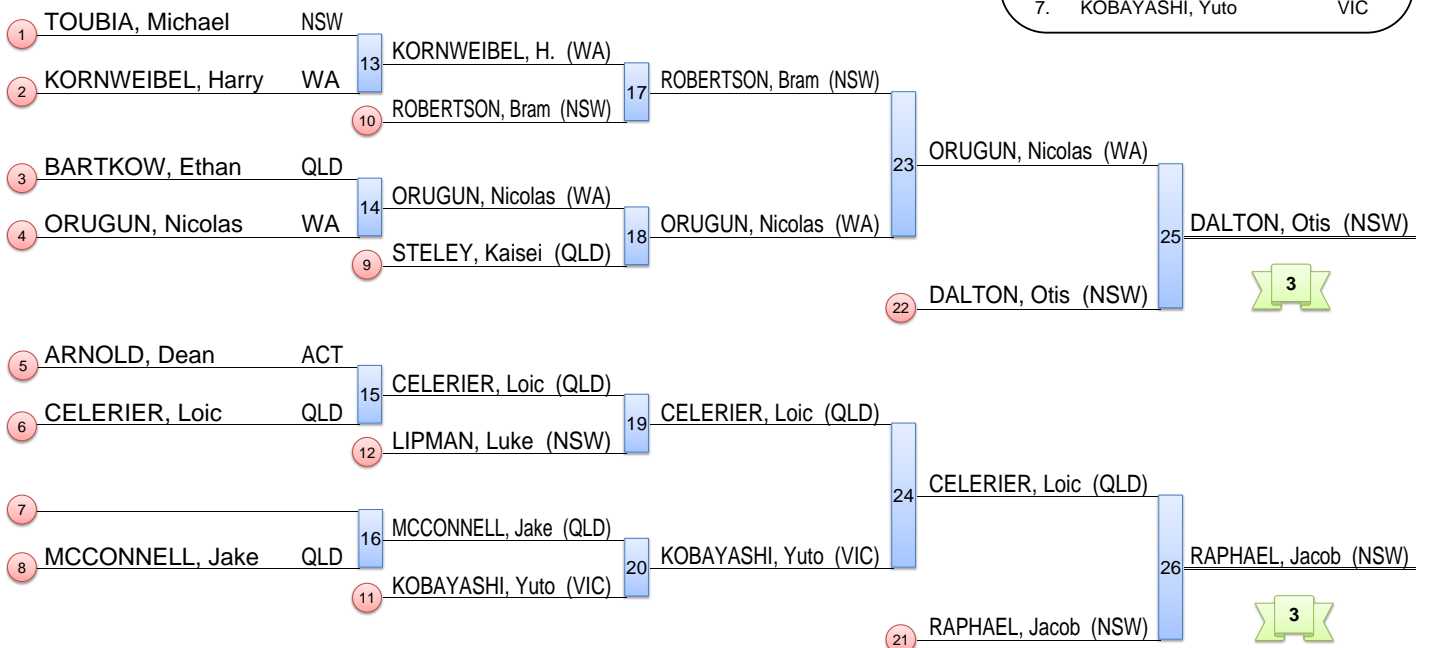

2022 Junior Boys and Girls Australian National Championships

Gold Coast (AUS), 11 Jun 2022

-42 kg

8 Judoka

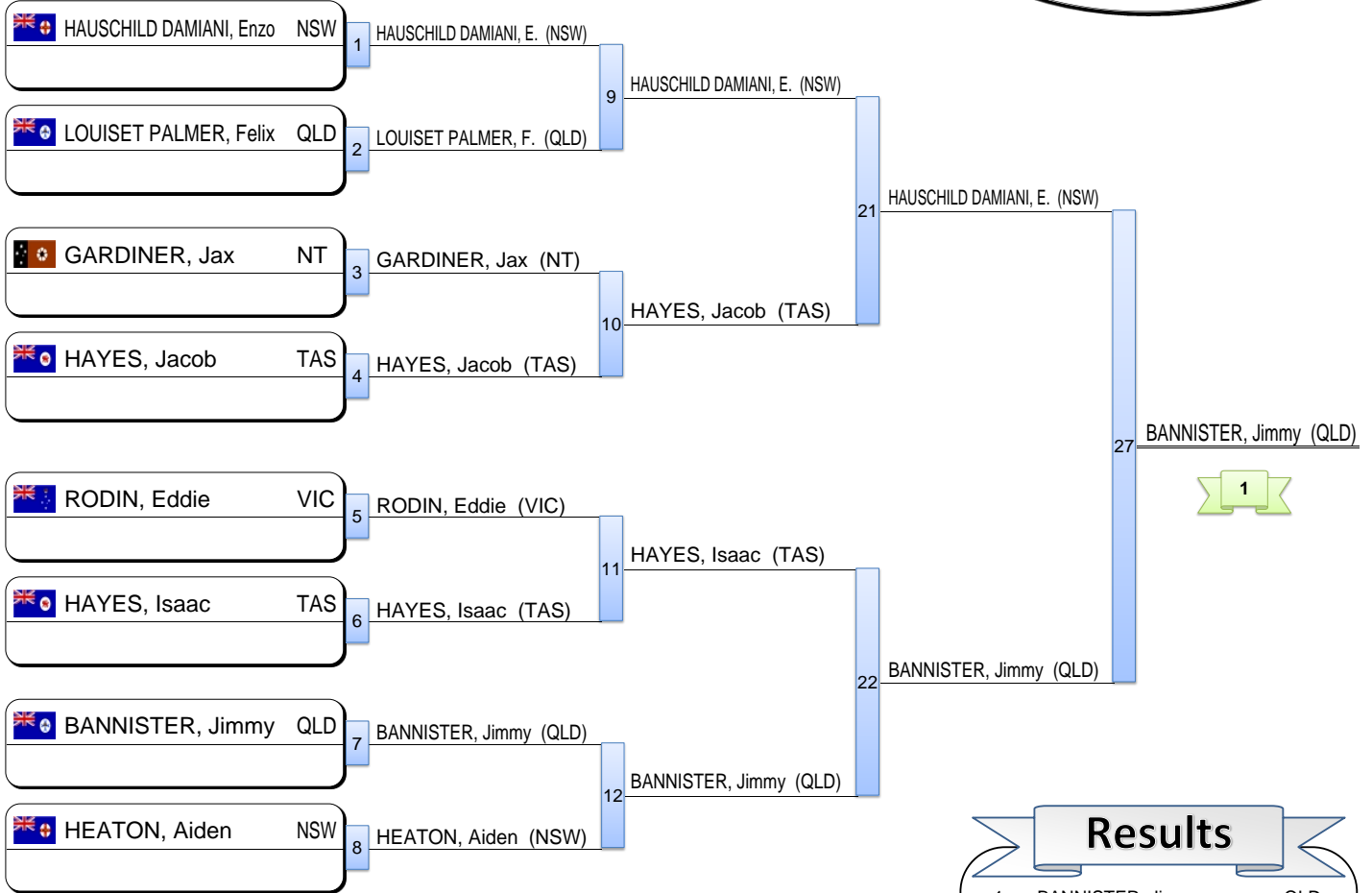

Results

1. BANNISTER, Jimmy QLD
2. HAUSCHILD DAMIANI, Enzo NSW
3. HAYES, Isaac TAS
3. HAYES, Jacob TAS
5. LOUISET PALMER, Felix QLD
5. RODIN, Eddie VIC
7. GARDINER, Jax NT
7. HEATON, Aiden NSW

Repechage

Loser contest x will appear at x in repechage

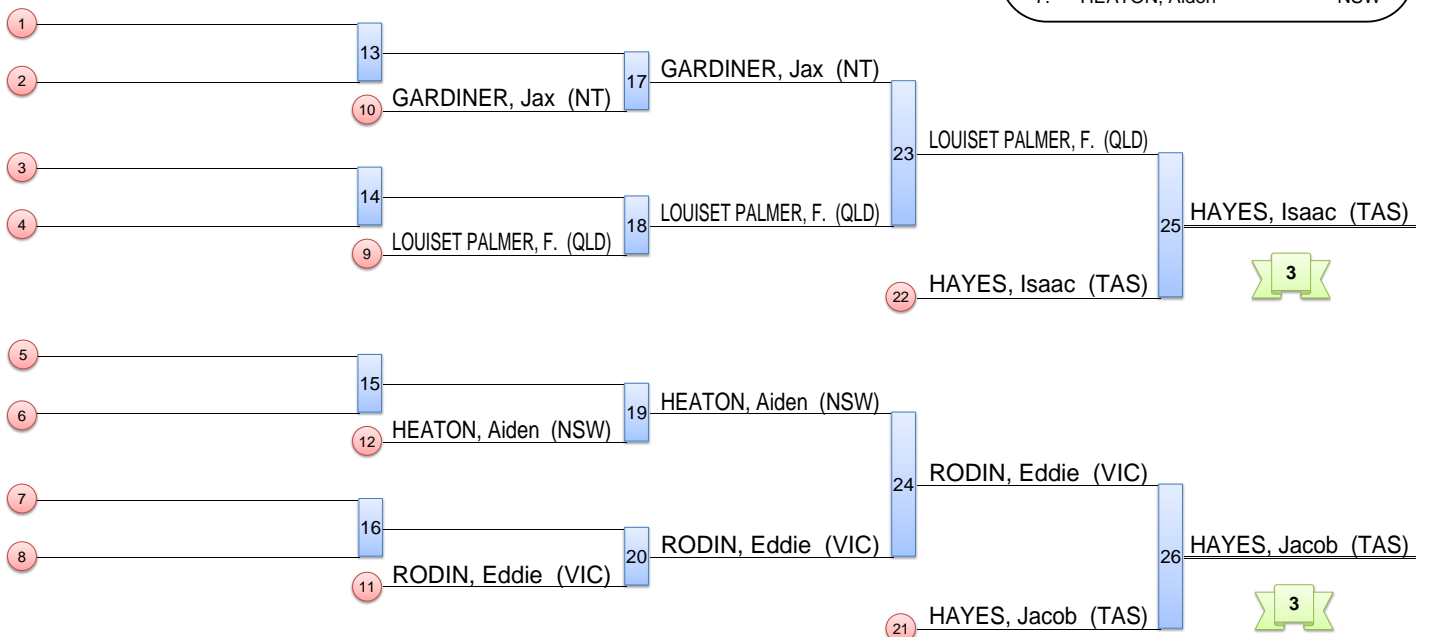

2022 Junior Boys and Girls Australian National Championships

Gold Coast (AUS), 11 Jun 2022

-46 kg

7 Judoka

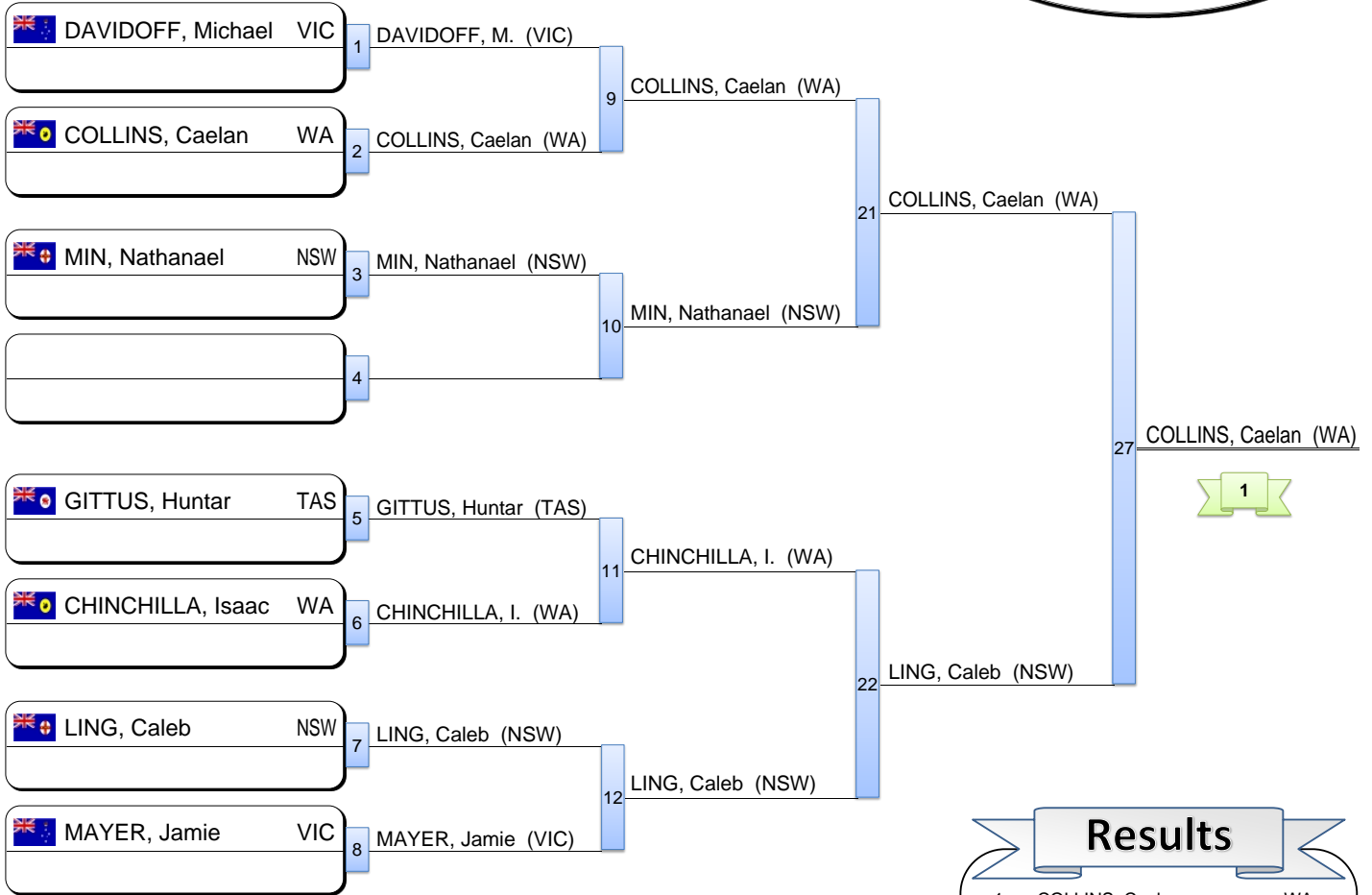

Results

1. COLLINS, Caelan WA
2. LING, Caleb NSW
3. CHINCHILLA, Isaac WA
3. MIN, Nathanael NSW
5. DAVIDOFF, Michael VIC
5. MAYER, Jamie VIC
- 7.
7. GITTUS, Hunter TAS

Repechage

Loser contest x will appear at x in repechage

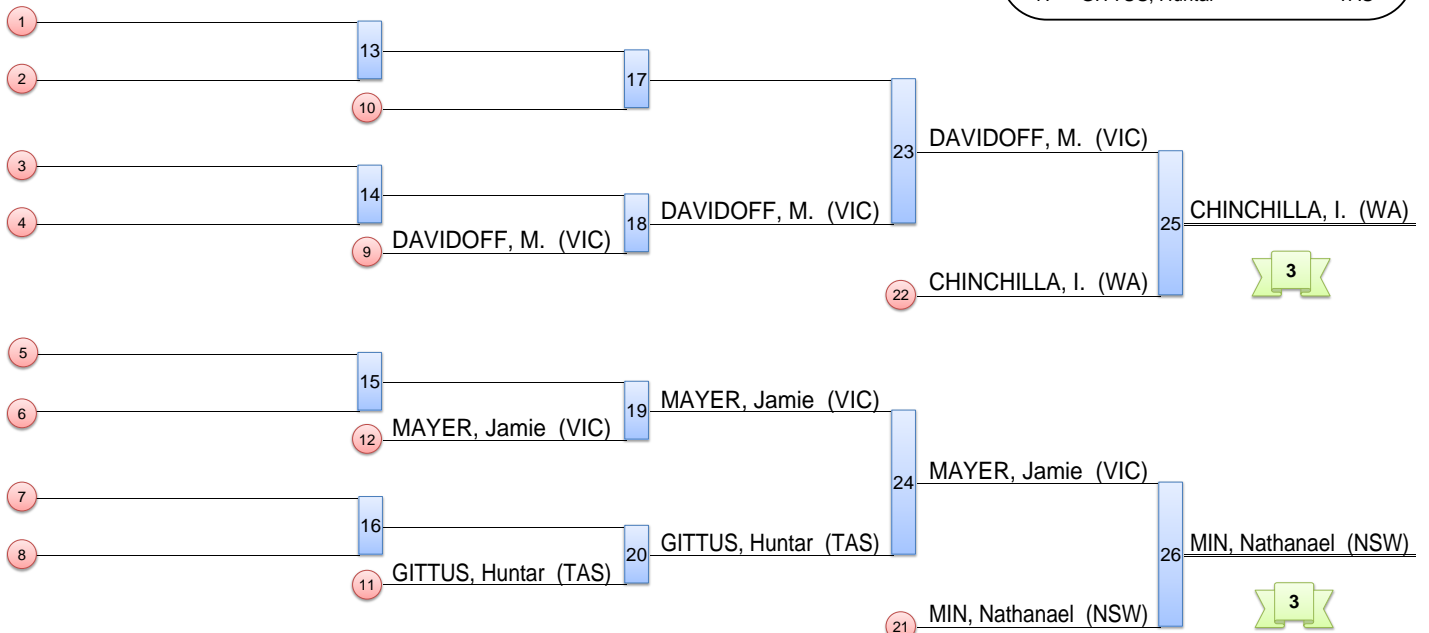

2022 Junior Boys and Girls Australian National Championships

Gold Coast (AUS), 11 Jun 2022

-50 kg

2 Judoka

BEST OF THREE

1	HOLMES, Frederick	QLD	1	HOLMES, Frederick	QLD
2	PIKE, Texas	NSW		01 / 00 s1	3:00

1	HOLMES, Frederick	QLD	2	PIKE, Texas	NSW
2	PIKE, Texas	NSW		00 / 01	3:15

1	HOLMES, Frederick	QLD	3	HOLMES, Frederick	QLD
2	PIKE, Texas	NSW		01 s2 / 00	3:00

Final Results

1. HOLMES, Frederick QLD
2. PIKE, Texas NSW

2022 Junior Boys and Girls Australian National Championships

Gold Coast (AUS), 11 Jun 2022

+50 kg

5 Judoka

			1	3	5	Wins Score	
1	LEE, Pio	NSW		1	1	2 0	
3	TAUMOEPEAU, Gabriel	ACT	0		0	0 0	
5	THIEU, Conrad	VIC	0	1		1 0	

			2	4	Wins	Scores
2	PRASAD, Marques	NSW		0		(0)
4	BAYARSAIKHAN, Michael	VIC	1			(0)

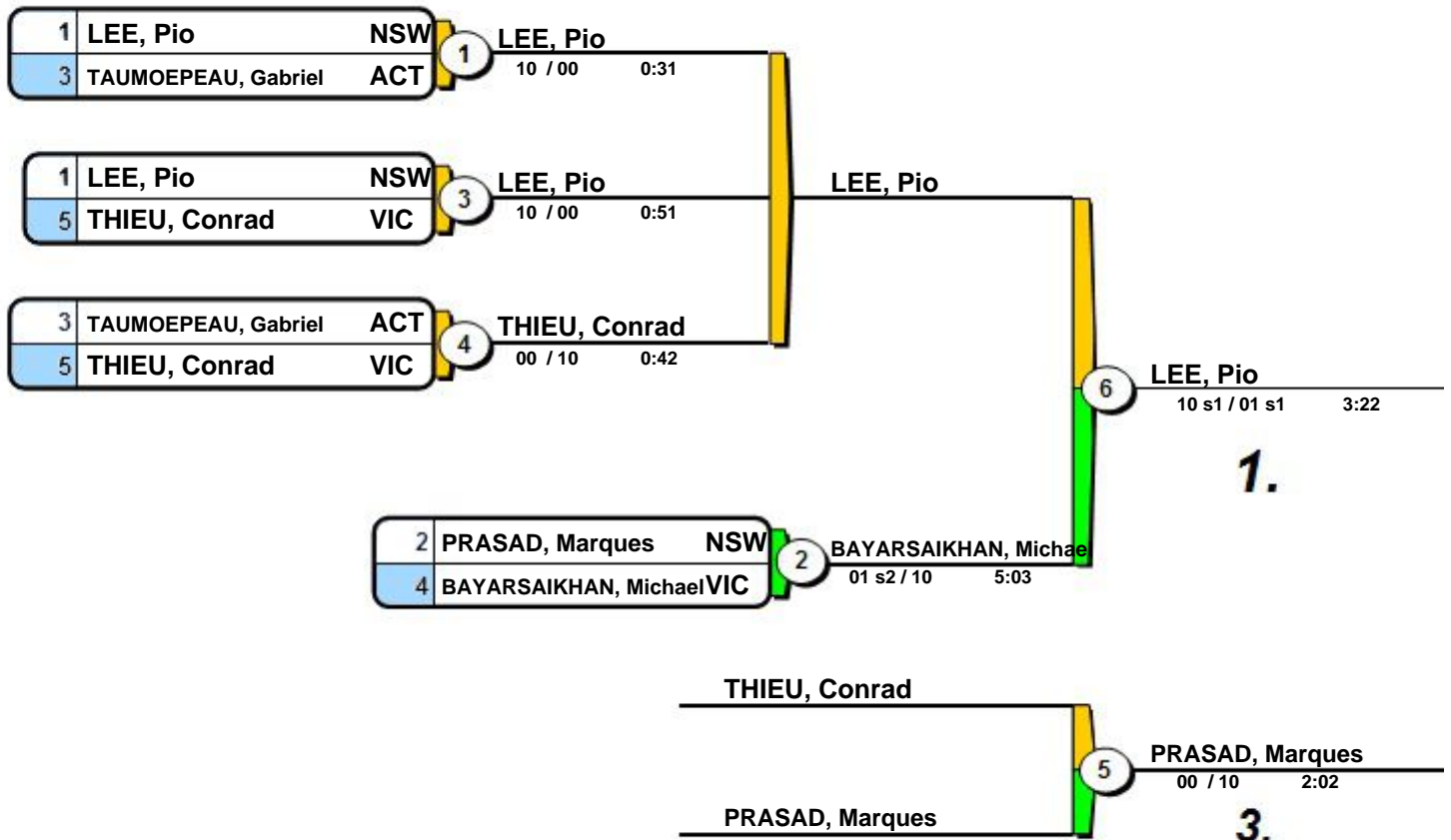

Final Results

1. LEE, Pio NSW
2. BAYARSAIKHAN, Michael VIC
3. PRASAD, Marques NSW

2022 Senior Boys and Girls Australian National Championships

Gold Coast (AUS), 11 Jun 2022

+63 kg

7 Judoka

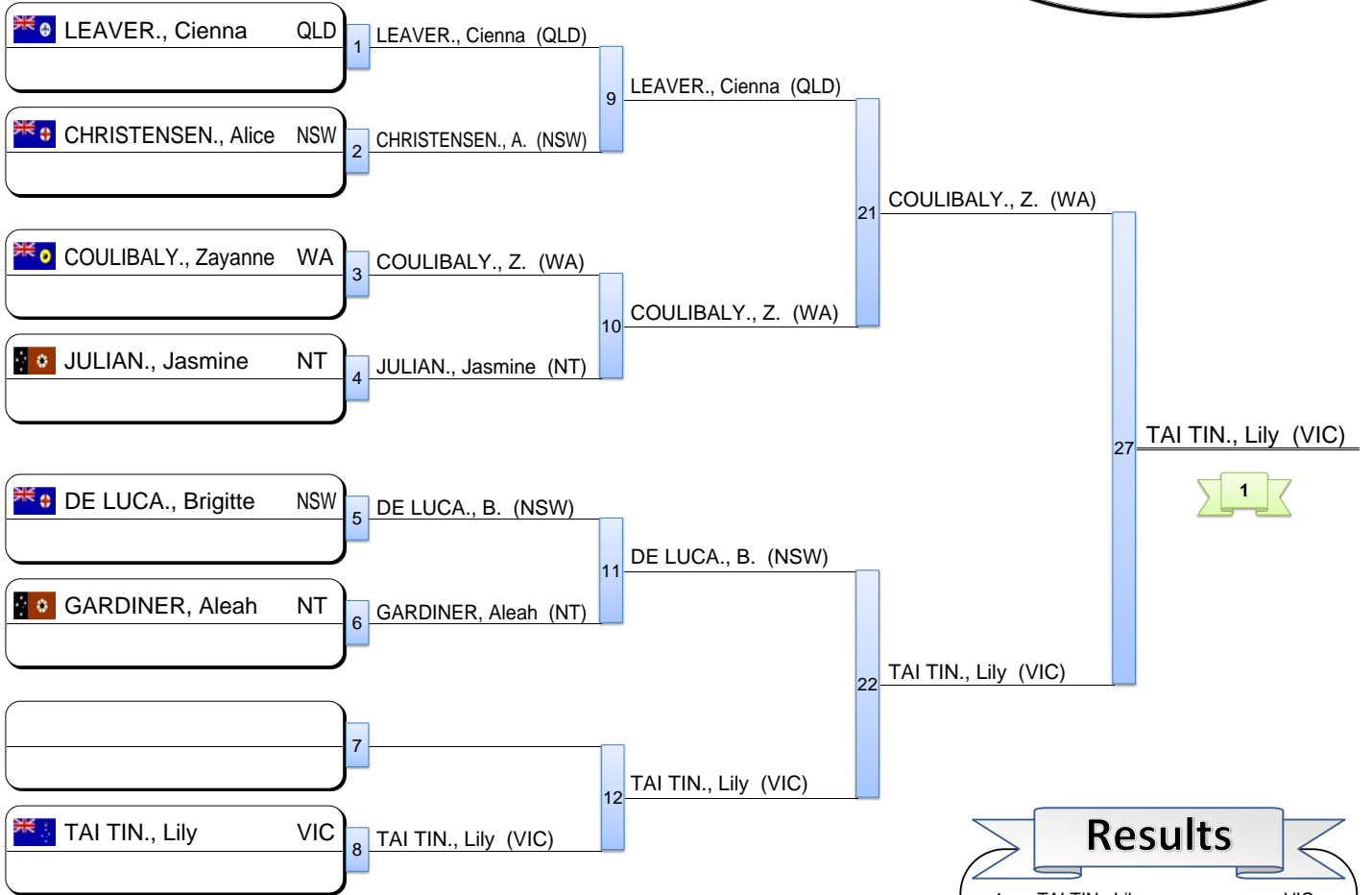

Results		
1.	TAI TIN., Lily	VIC
2.	COULIBALY., Z. (WA)	WA
3.	DE LUCA., Brigitte	NSW
3.	GARDINER, Aleah	NT
5.	CHRISTENSEN., Alice	NSW
5.	LEAVER., Cienna	QLD
7.	JULIAN., Jasmine	NT
7.		

Repechage

Loser contest **x** will appear at **x** in repechage

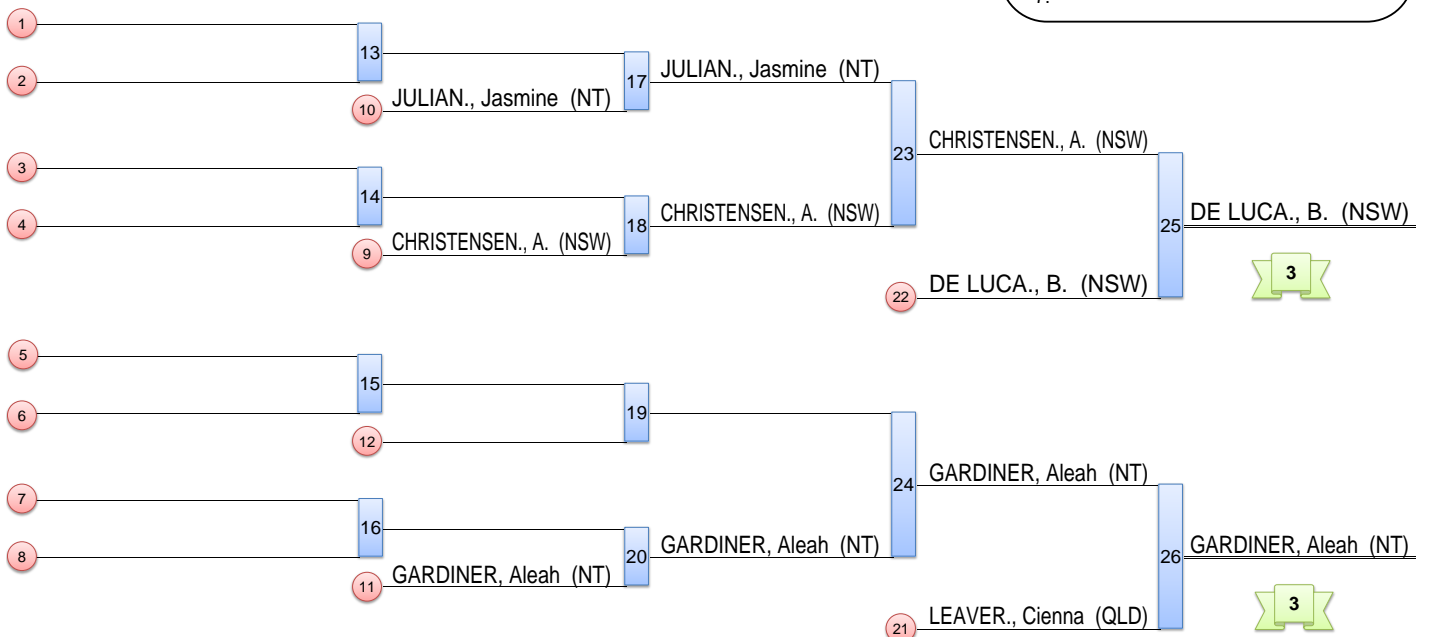

2022 Senior Boys and Girls Australian National Championships

Gold Coast (AUS), 11 Jun 2022

-36G kg

4 Judoka

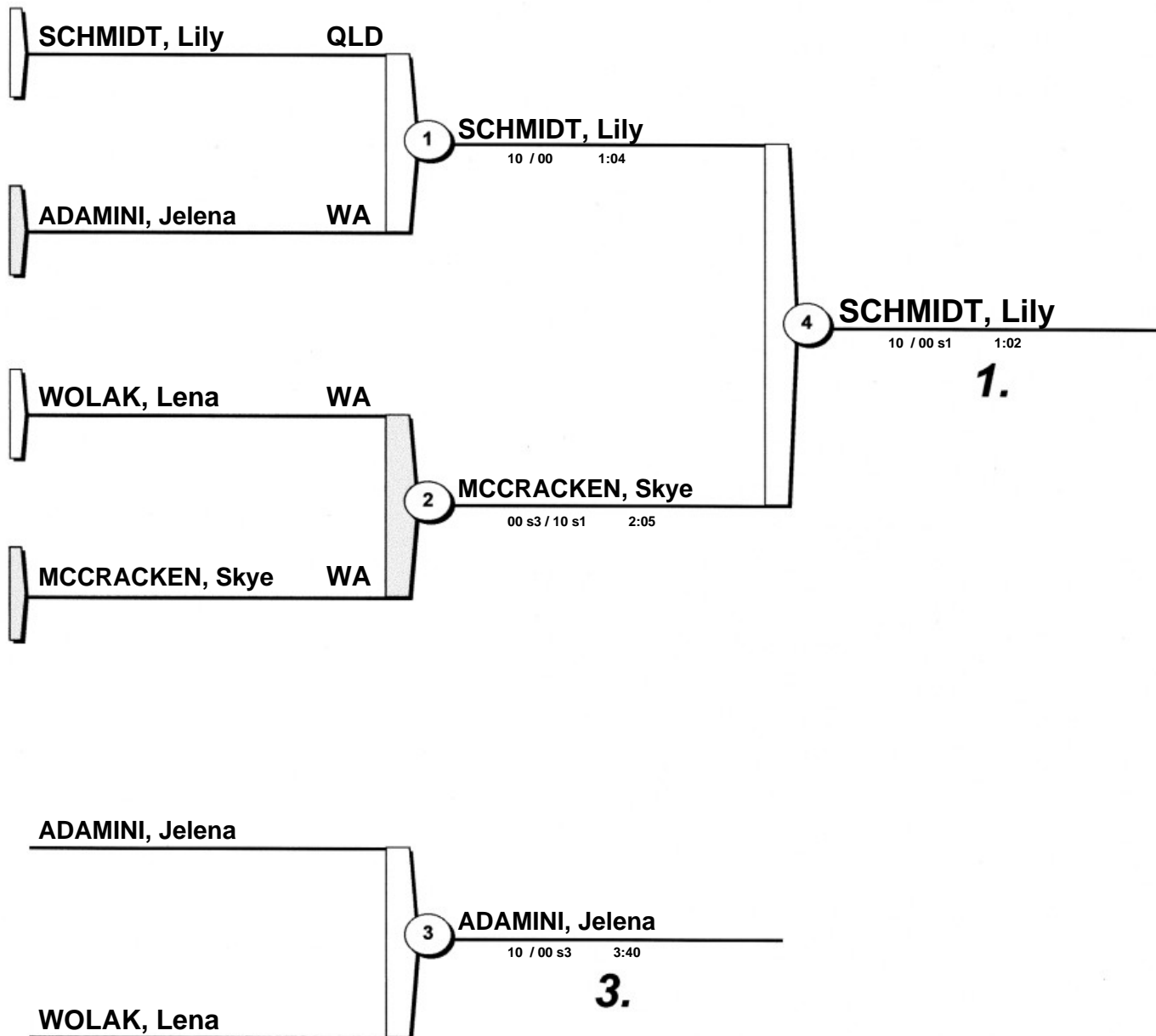

Final Results

- | | |
|--------------------|-----|
| 1. SCHMIDT, Lily | QLD |
| 2. MCCRACKEN, Skye | WA |
| 3. ADAMINI, Jelena | WA |

2022 Senior Boys and Girls Australian National Championships

Gold Coast (AUS), 11 Jun 2022

-44 kg

6 Judoka

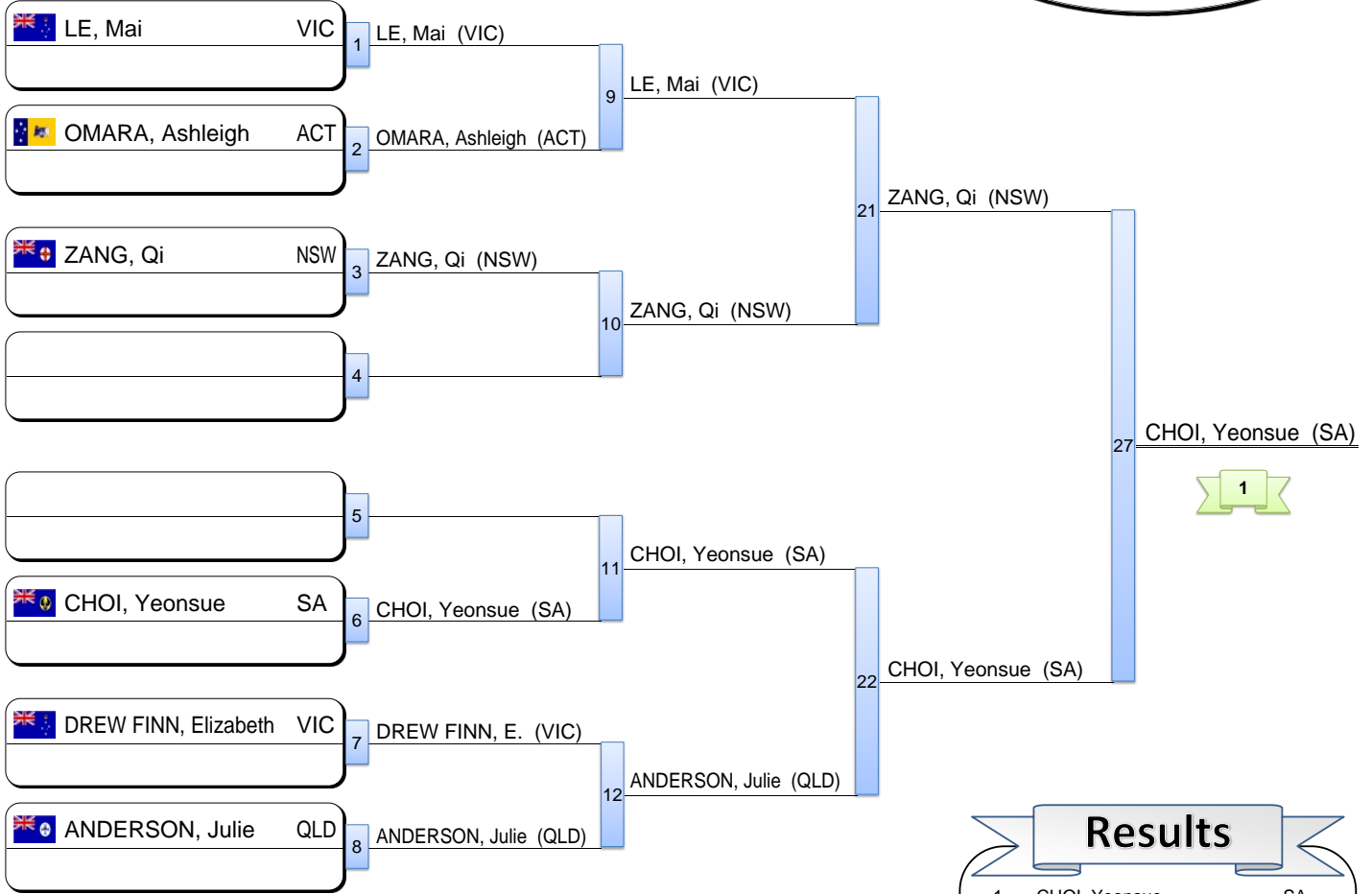

Results

1. CHOI, Yeonsue SA
2. ZANG, Qi NSW
3. ANDERSON, Julie QLD
3. LE, Mai VIC
5. OMARA, Ashleigh ACT
5. DREW FINN, Elizabeth VIC
- 7.
- 7.

Repechage

Loser contest **x** will appear at **x** in repechage

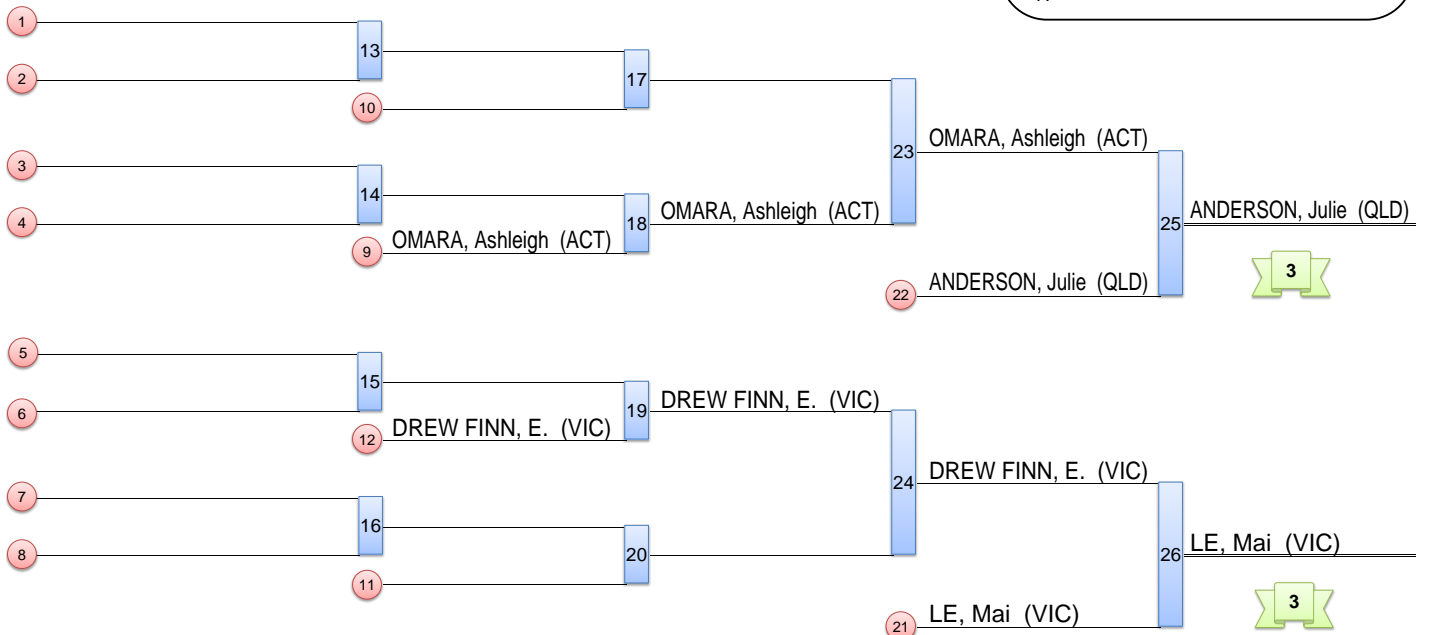

2022 Senior Boys and Girls Australian National Championships

Gold Coast (AUS), 11 Jun 2022

-48 kg

7 Judoka

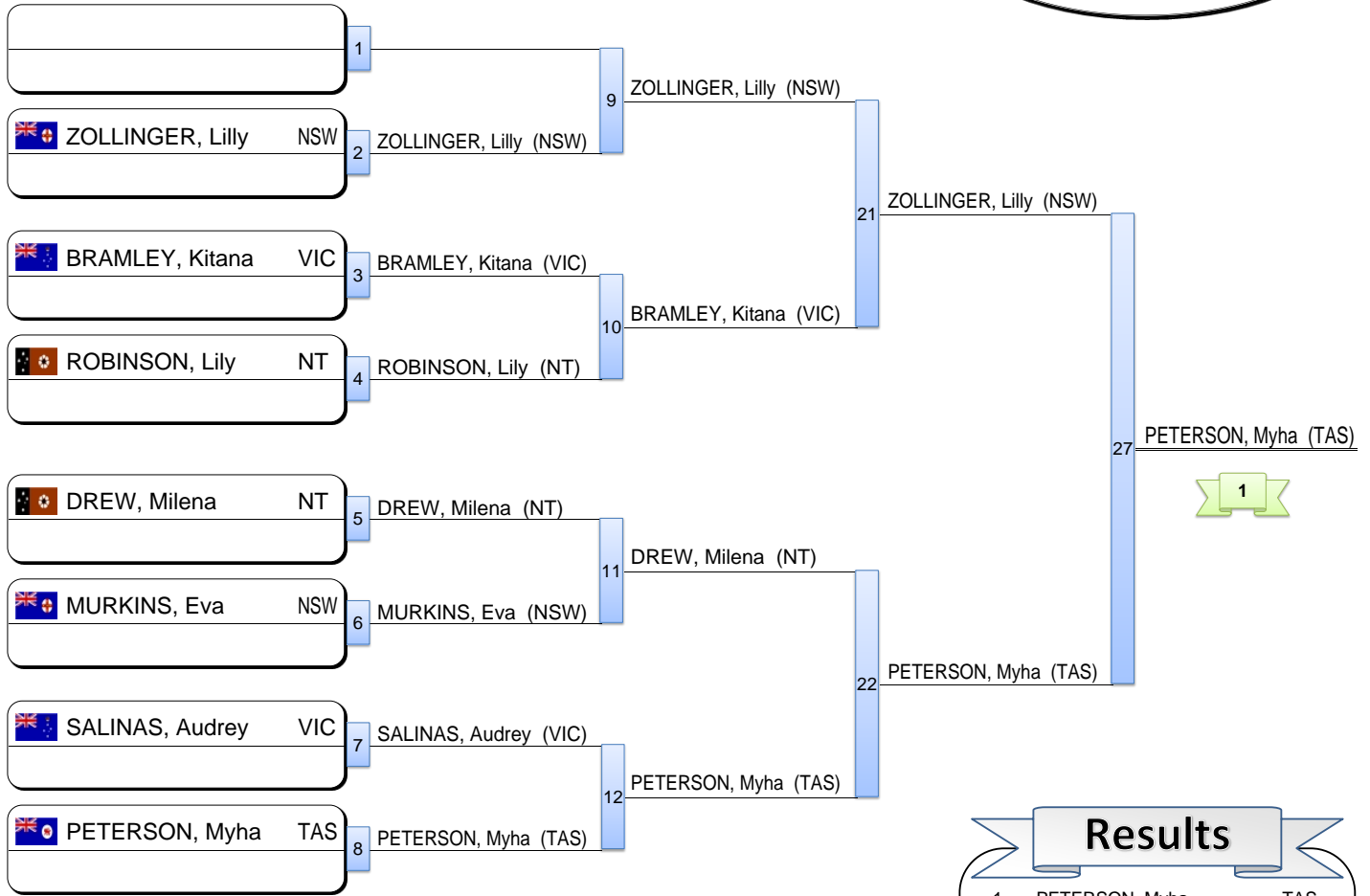

Results

1. PETERSON, Myha TAS
2. ZOLLINGER, Lilly NSW
3. DREW, Milena NT
3. SALINAS, Audrey VIC
5. ROBINSON, Lily NT
5. BRAMLEY, Kitana VIC
- 7.
7. MURKINS, Eva NSW

Repechage

Loser contest **x** will appear at **x** in repechage

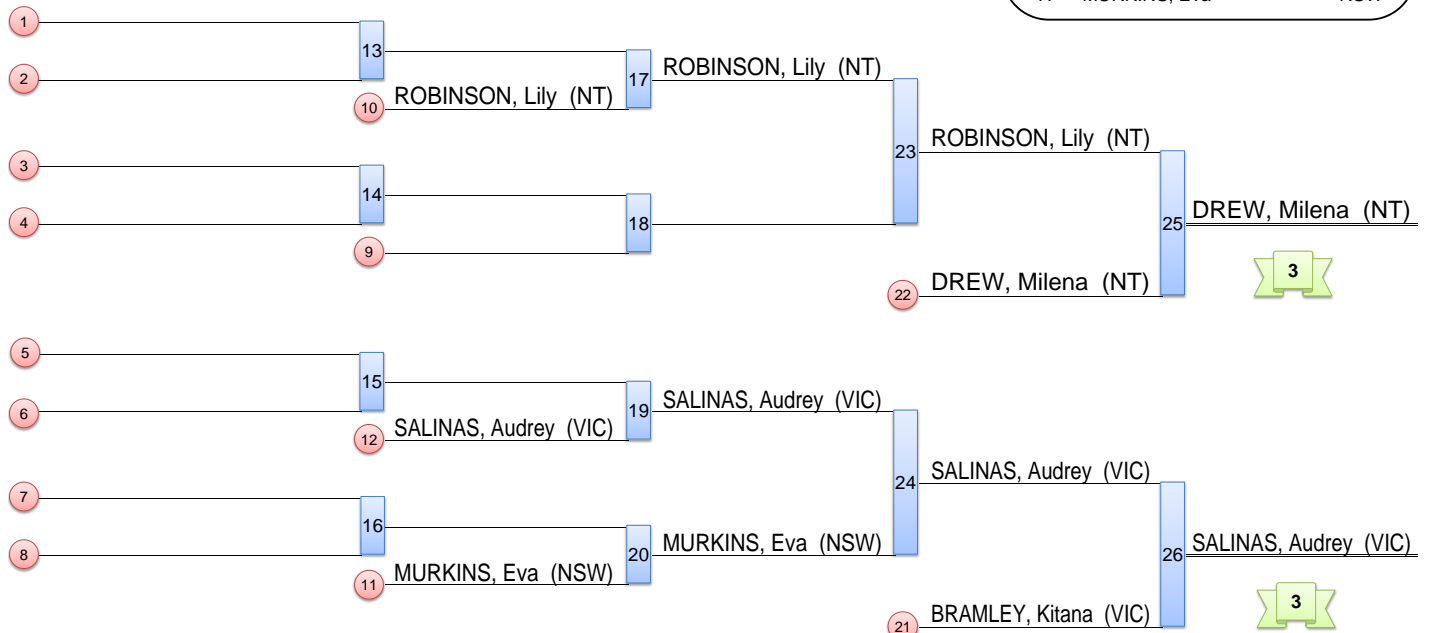

2022 Senior Boys and Girls Australian National Championships

Gold Coast (AUS), 11 Jun 2022

-52 kg

9 Judoka

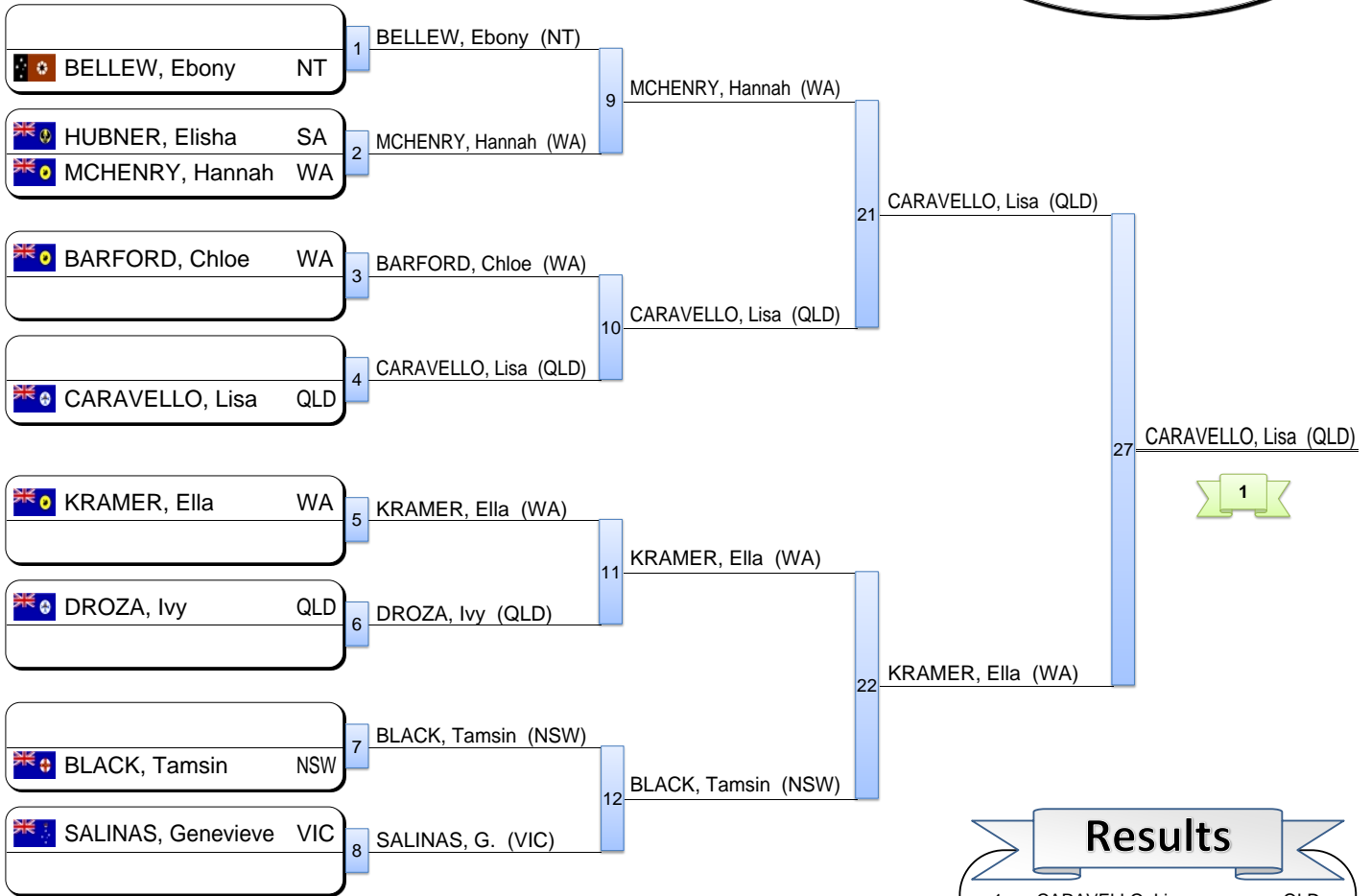

Results

1. CARAVELLO, Lisa QLD
2. KRAMER, Ella WA
3. BELLEW, Ebony NT
3. MCHENRY, Hannah WA
5. BLACK, Tamsin NSW
5. SALINAS, Genevieve VIC
7. HUBNER, Elisha SA
7. DROZA, Ivy QLD

Repechage

Loser contest **x** will appear at **x** in repechage

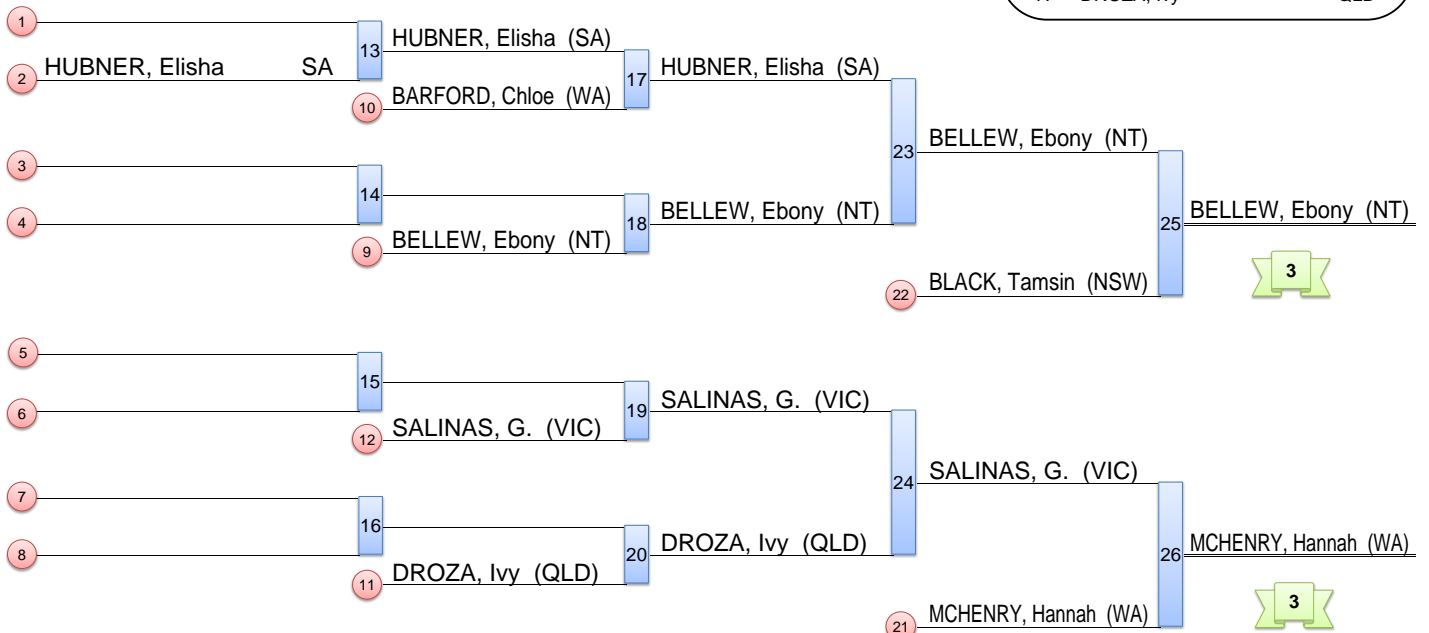

2022 Senior Boys and Girls Australian National Championships

Gold Coast (AUS), 11 Jun 2022

-57 kg

7 Judoka

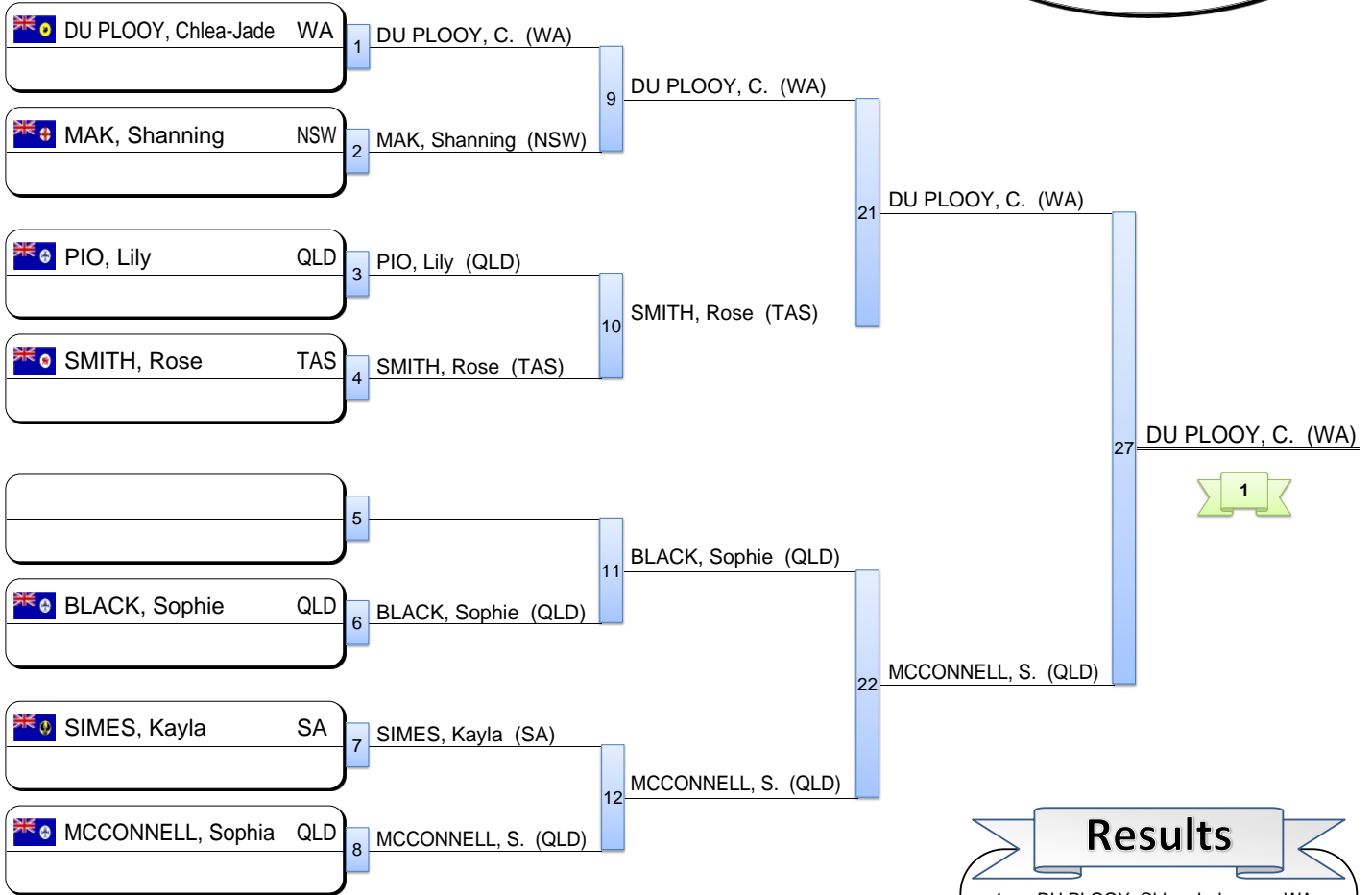

Results

1. DU PLOOY, Chlea-Jade WA
2. MCCONNELL, Sophia QLD
3. BLACK, Sophie QLD
3. SMITH, Rose TAS
5. PIO, Lily QLD
5. SIMES, Kayla SA
7. MAK, Shanning NSW
- 7.

Repechage

Loser contest x will appear at x in repechage

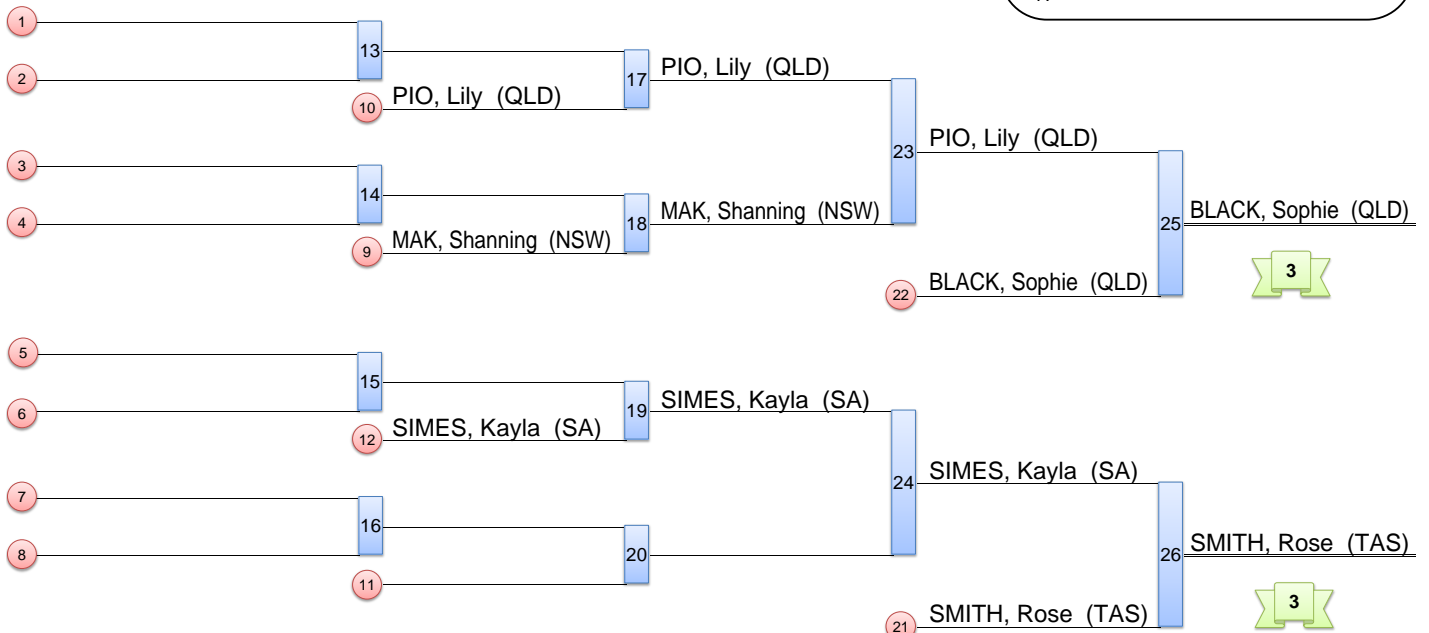

2022 Senior Boys and Girls Australian National Championships

Gold Coast (AUS), 11 Jun 2022

-63 kg

8 Judoka

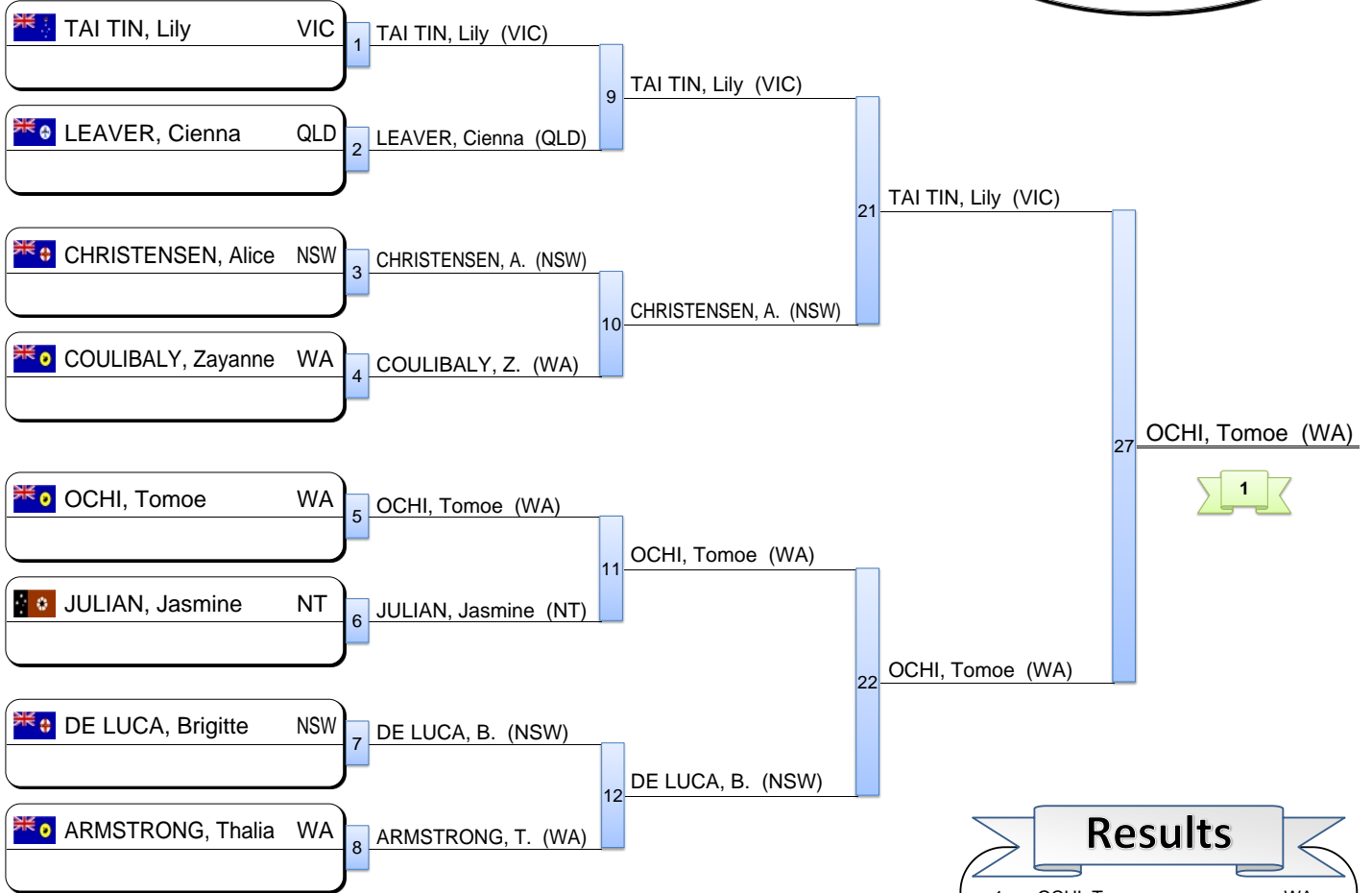

Repechage

Loser contest x will appear at x in repechage

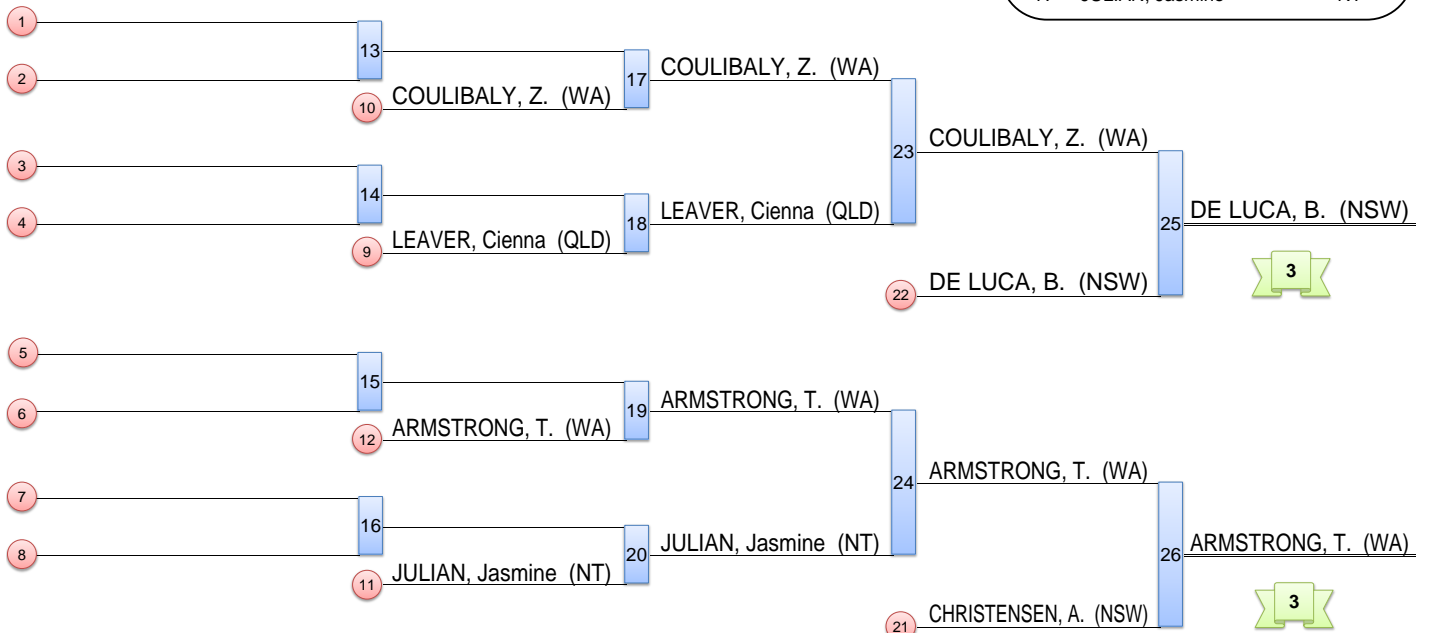

-32B kg

2 Judoka

BEST OF THREE

1	BRUNET GRESEQUE, Tom	SA	1	BRUNET GRESEQUE, Tom	SA	10 / 00	1:49
2	HAARING, Zack	NSW					

1	BRUNET GRESEQUE, Tom	SA	2	BRUNET GRESEQUE, Tom	SA	10 s1 / 00	2:29
2	HAARING, Zack	NSW					

1	BRUNET GRESEQUE, Tom	SA	3	BRUNET GRESEQUE, Tom	SA		
2	HAARING, Zack	NSW					

Final Results

1. BRUNET GRESEQUE, Tom SA
2. HAARING, Zack NSW

2022 Senior Boys and Girls Australian National Championships

Gold Coast (AUS), 11 Jun 2022

-36B kg

4 Judoka

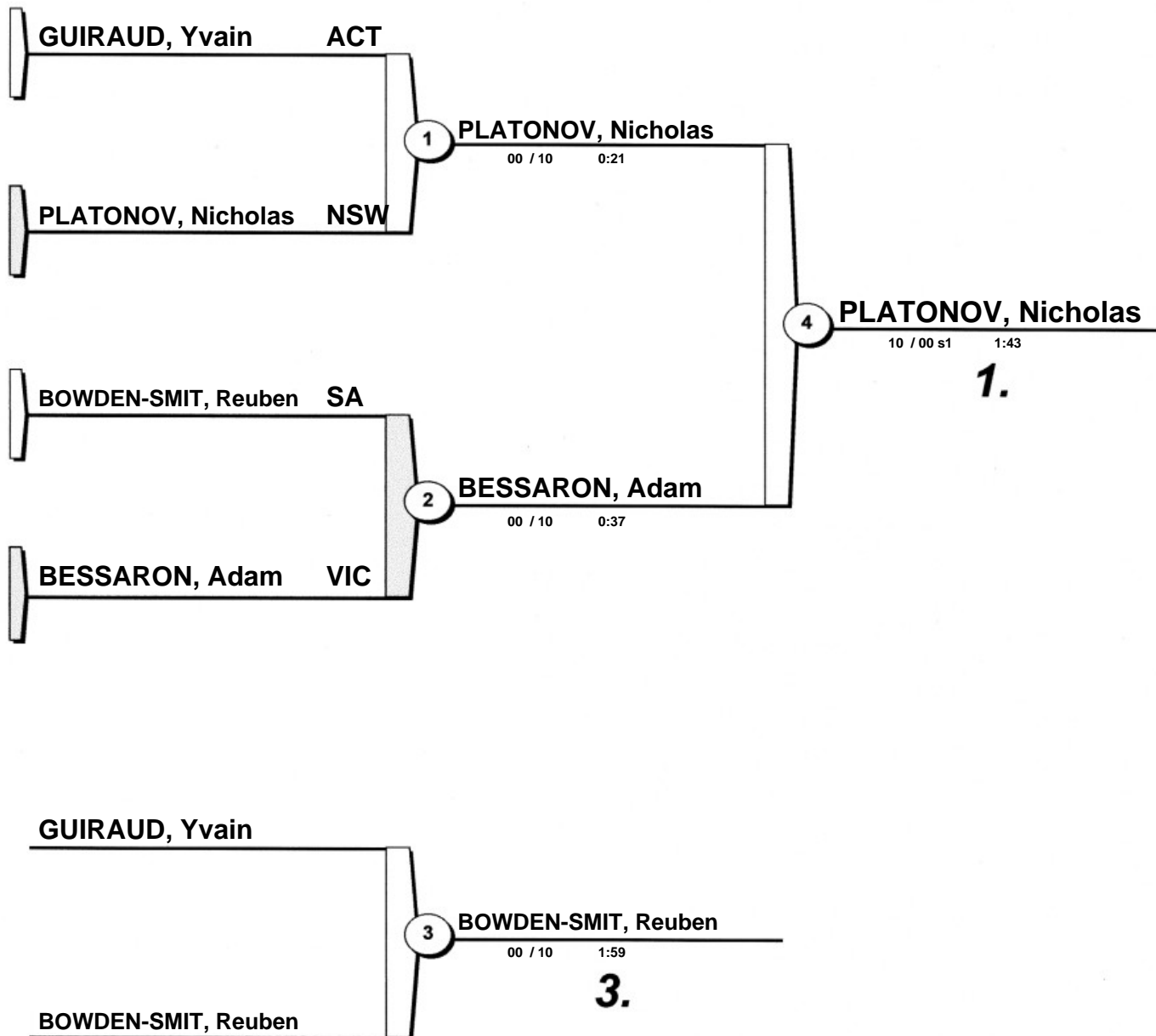

Final Results

1. PLATONOV, Nicholas NSW
2. BESSARON, Adam VIC
3. BOWDEN-SMIT, Reuben SA

2022 Senior Boys and Girls Australian National Championships

Gold Coast (AUS), 11 Jun 2022

-40B kg

11 Judoka

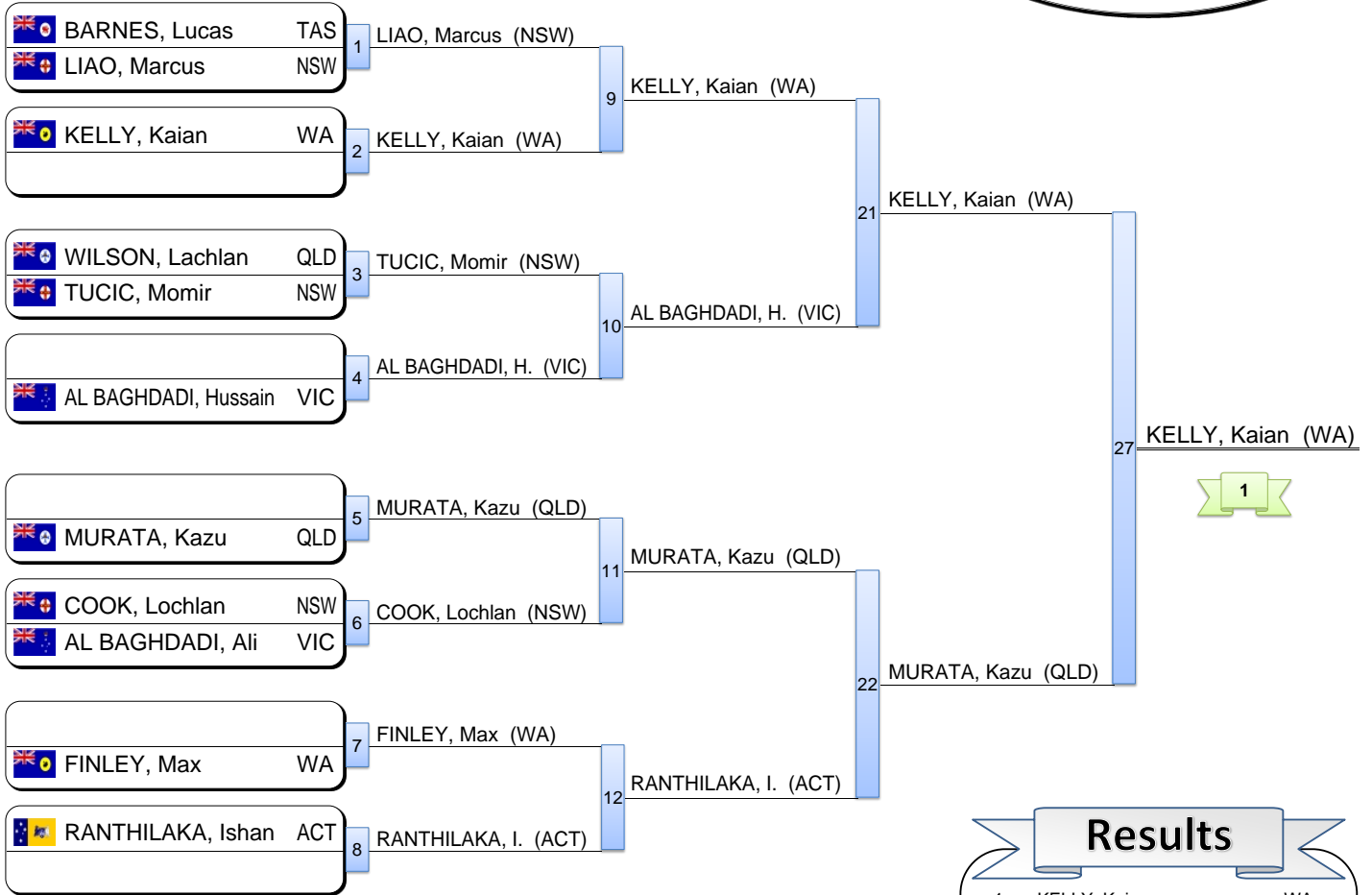

Results

1. KELLY, Kaian (WA)
2. MURATA, Kazu (QLD)
3. RANTHILAKA, Ishan (ACT)
3. COOK, Lochlan (NSW)
5. TUCIC, Momir (NSW)
5. AL BAGHDADI, Hussain (VIC)
7. LIAO, Marcus (NSW)
7. FINLEY, Max (WA)

Repechage

Loser contest will appear at in repechage

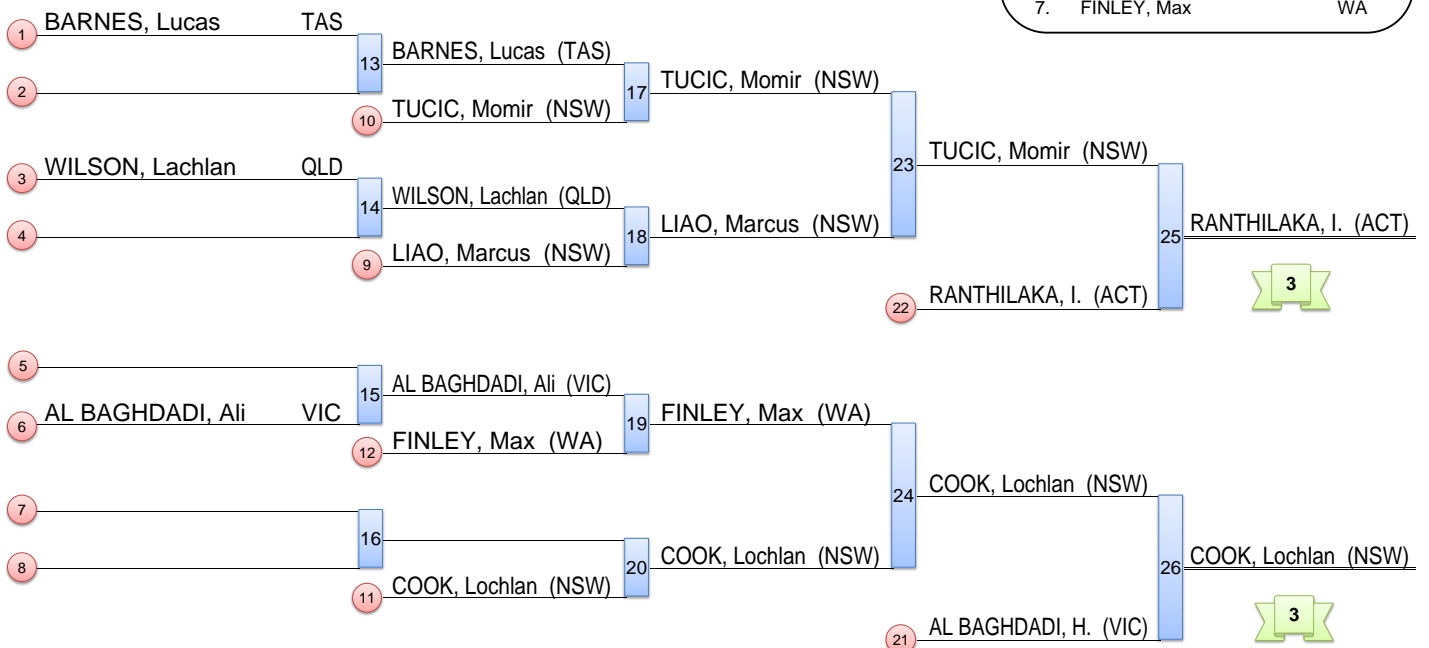

2022 Senior Boys and Girls Australian National Championships

Gold Coast (AUS), 11 Jun 2022

-45 kg

17 Judoka

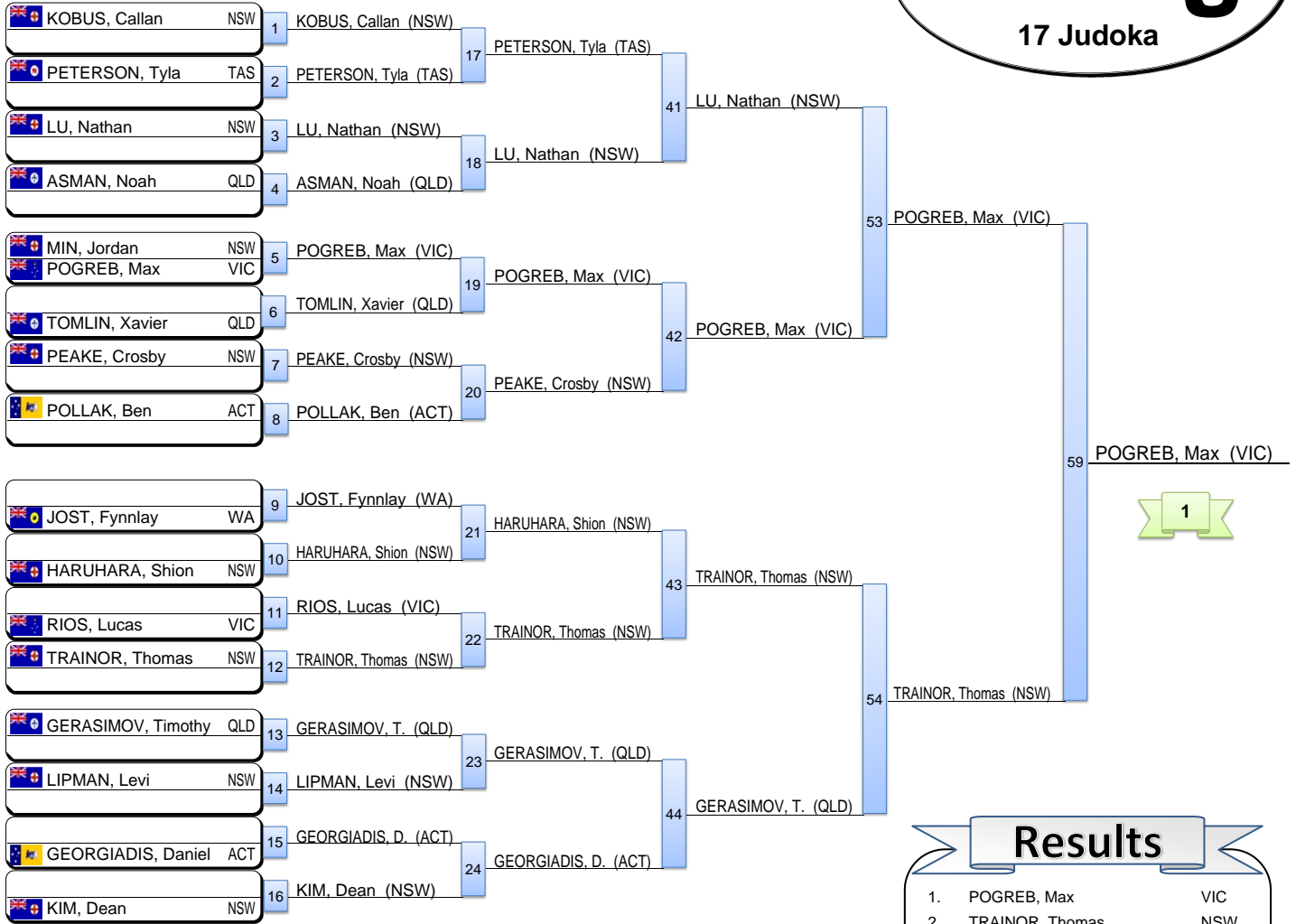

Repechage

Loser contest will appear at in repechage

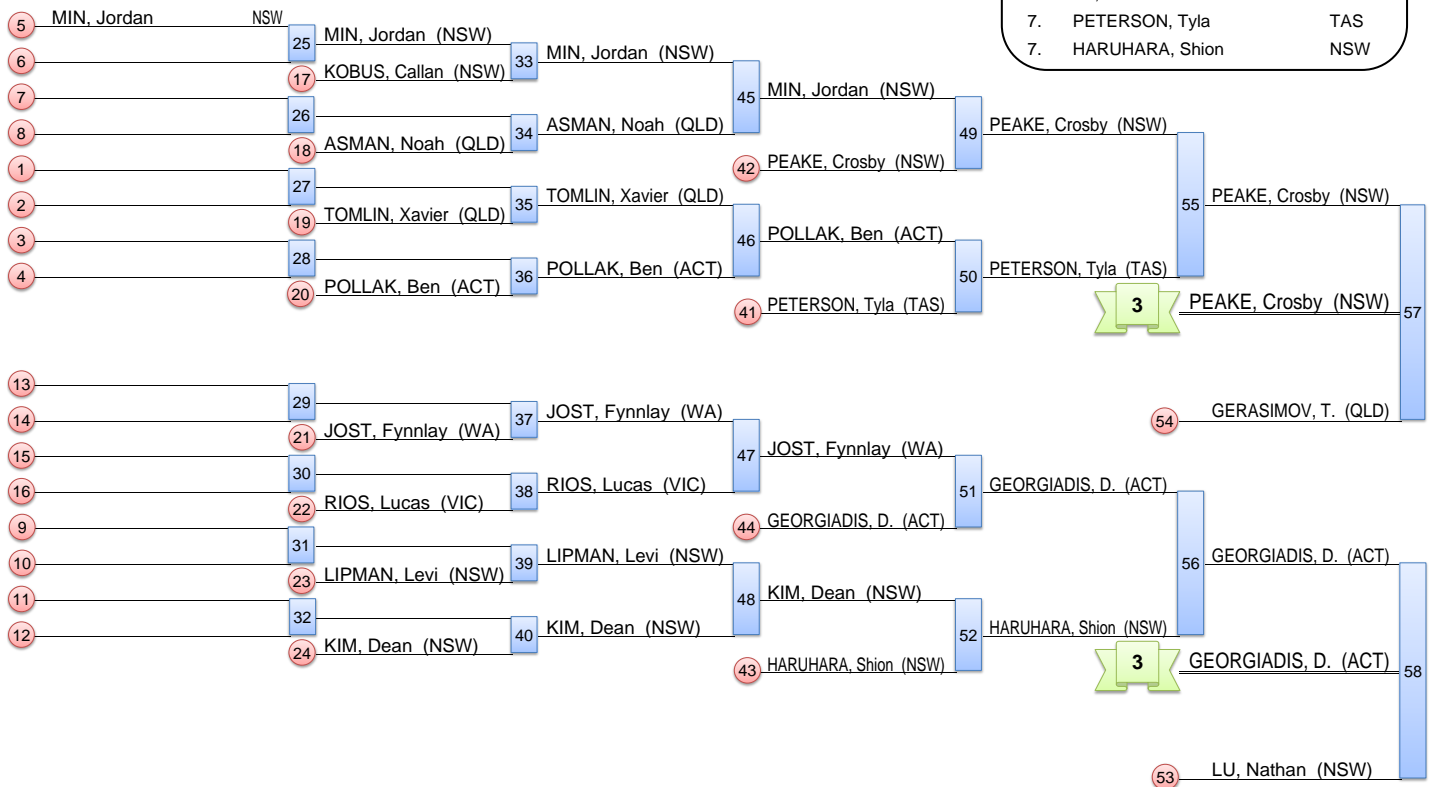

2022 Senior Boys and Girls Australian National Championships

Gold Coast (AUS), 11 Jun 2022

-50 kg

22 Judoka

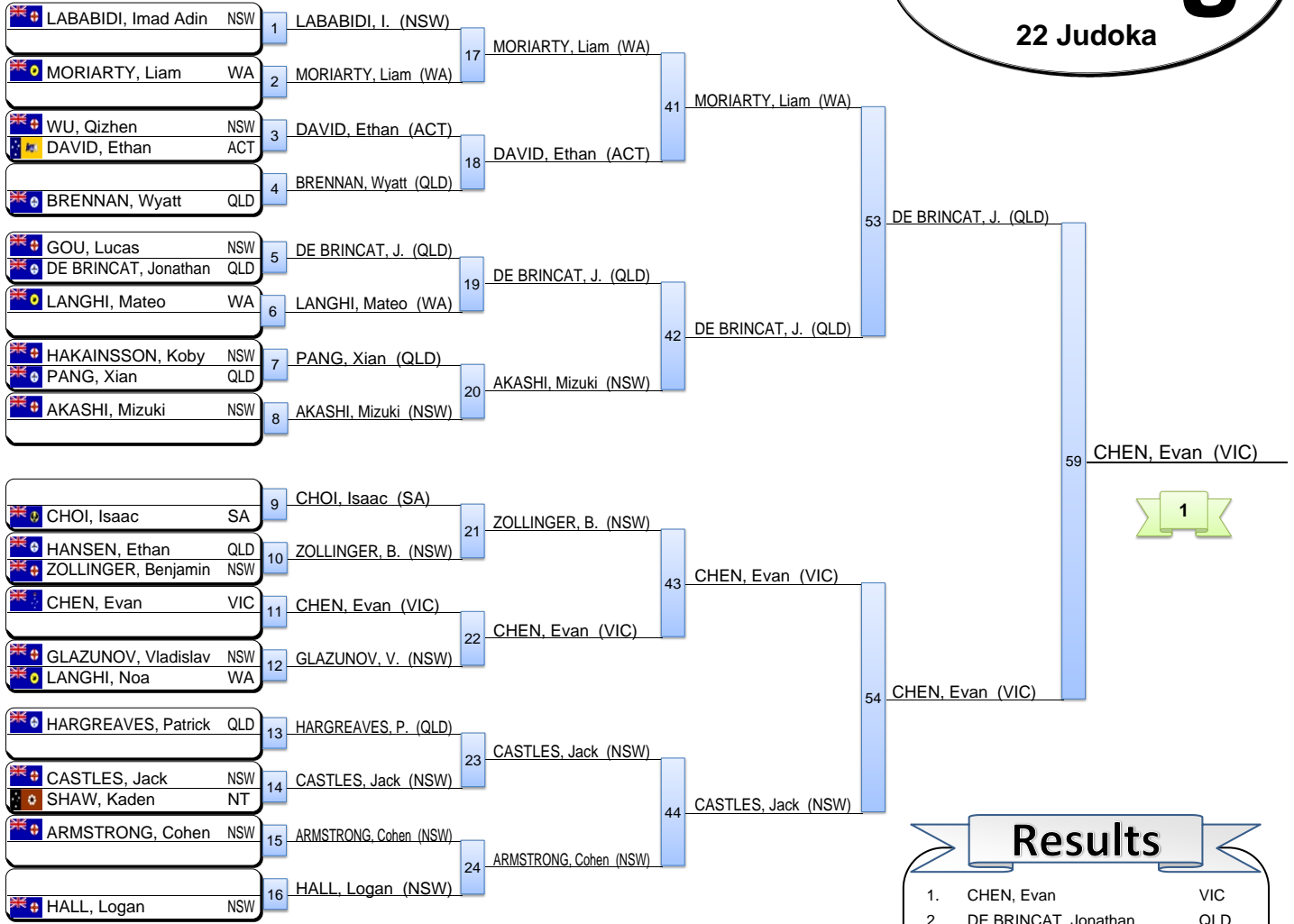

Results

1. CHEN, Evan VIC
2. DE BRINCAT, Jonathan QLD
3. AKASHI, Mizuki NSW
3. LANGHI, Noa WA
5. CASTLES, Jack NSW
5. MORIARTY, Liam WA
7. LANGHI, Mateo WA
7. GLAZUNOV, Vladislav NSW

Repechage

Loser contest will appear at in repechage

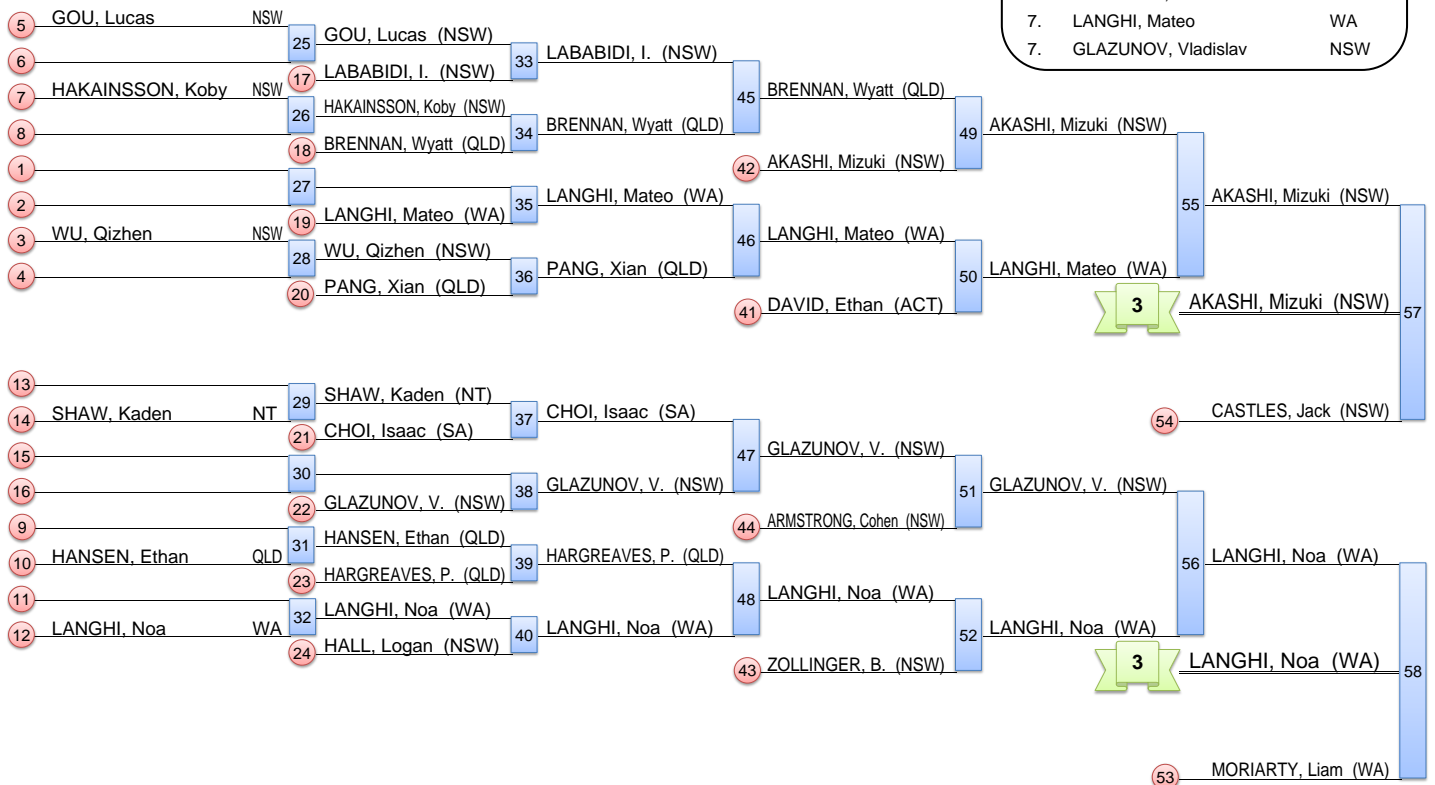

2022 Senior Boys and Girls Australian National Championships

Gold Coast (AUS), 11 Jun 2022

-55 kg

9 Judoka

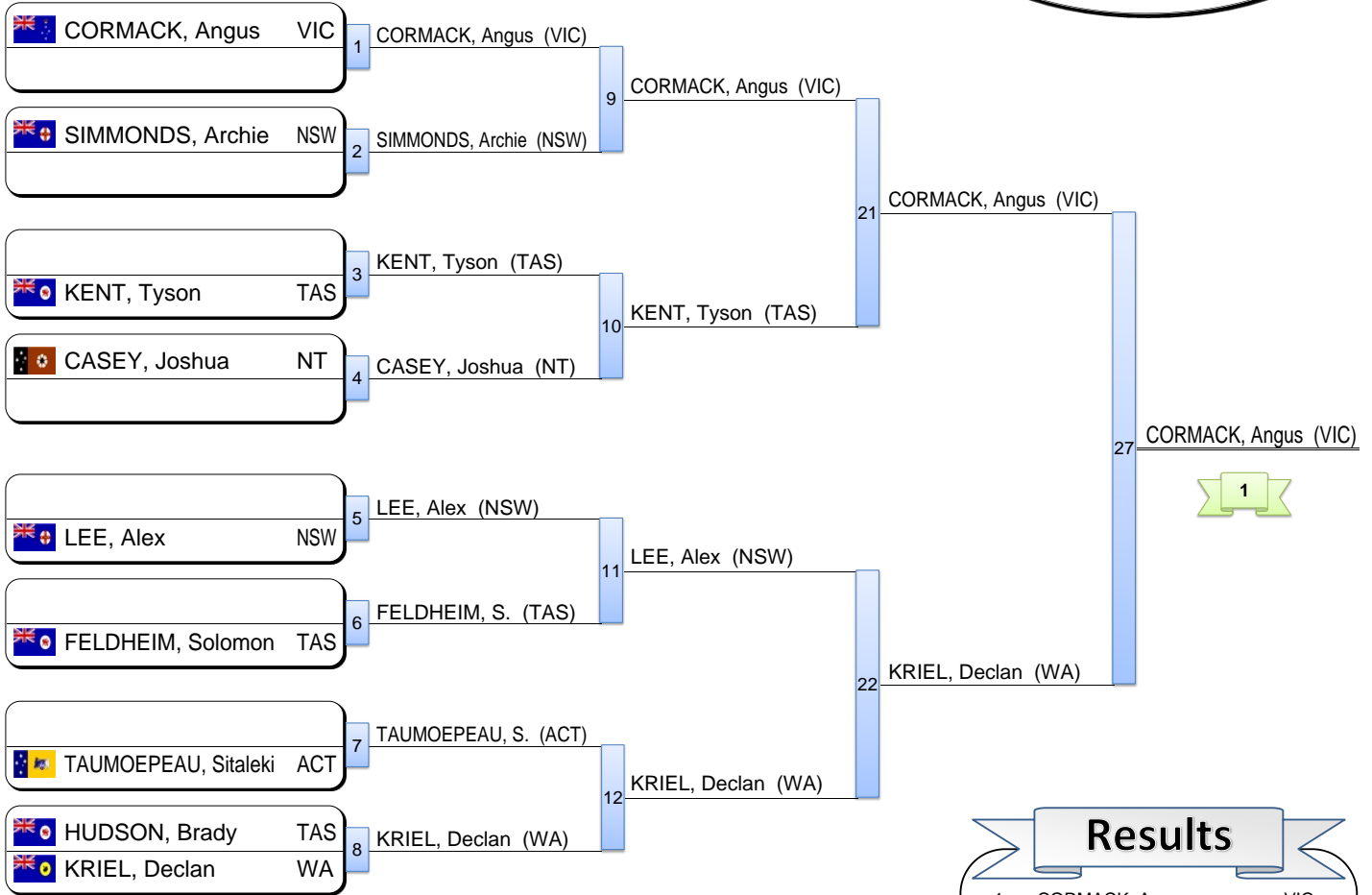

Results

1. CORMACK, Angus VIC
2. KRIEL, Declan WA
3. SIMMONDS, Archie NSW
3. KENT, Tyson TAS
5. LEE, Alex NSW
5. HUDSON, Brady TAS
7. CASEY, Joshua NT
7. TAUMOEPEAU, Sitaleki ACT

Repechage

Loser contest x will appear at x in repechage

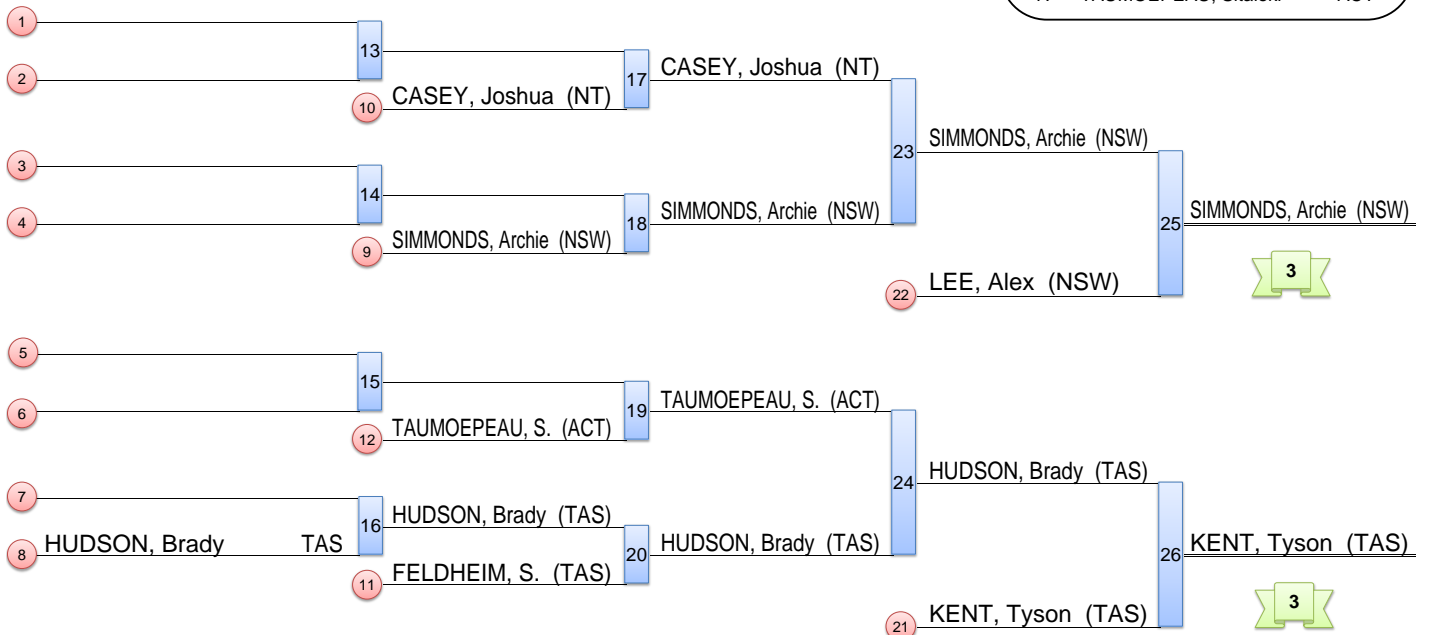

2022 Senior Boys and Girls Australian National Championships

Gold Coast (AUS), 11 Jun 2022

-60 kg

10 Judoka

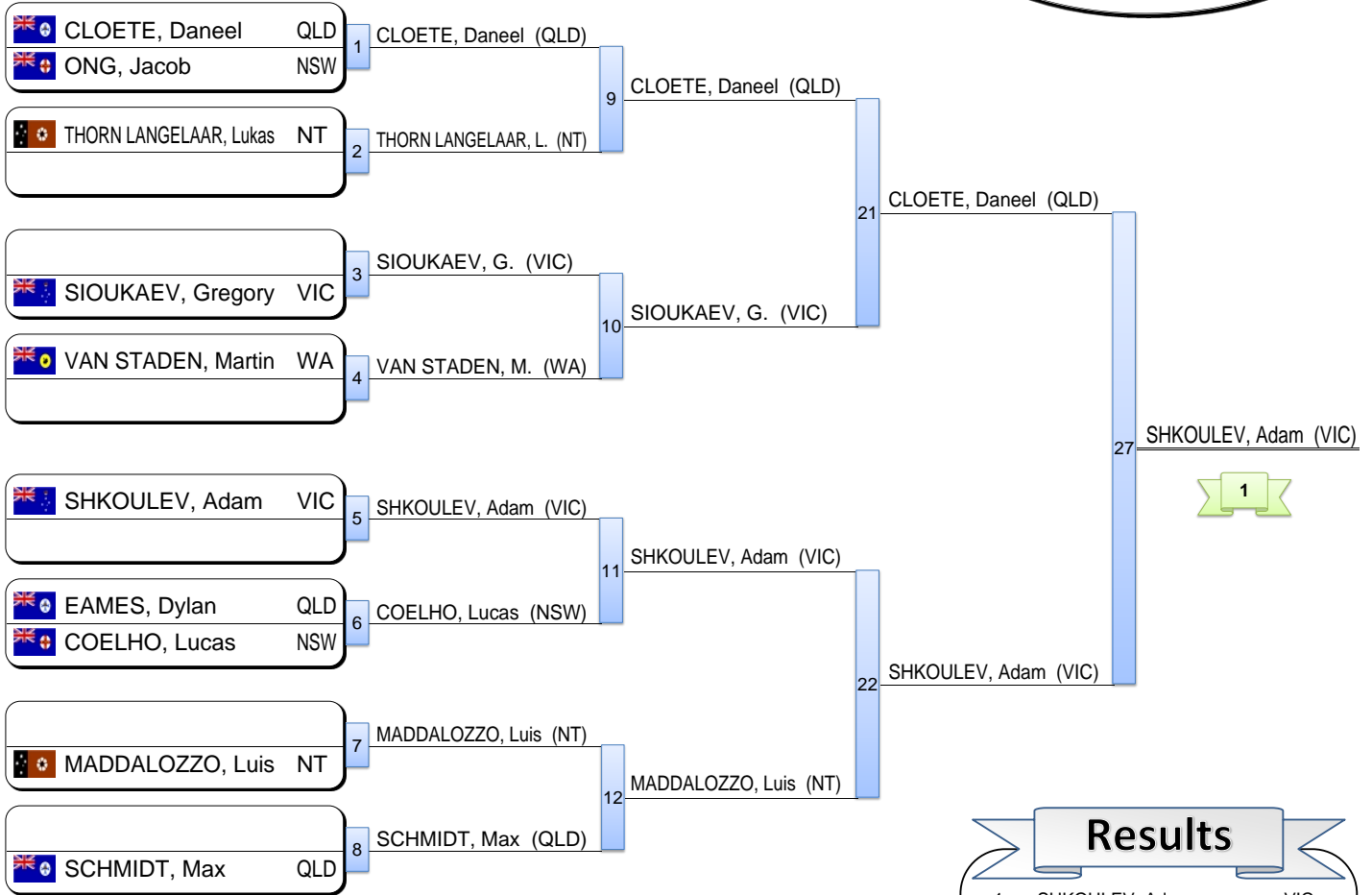

Results

1. SHKOULEV, Adam VIC
2. CLOETE, Daneel QLD
3. VAN STADEN, Martin WA
3. SIOUKAEV, Gregory VIC
5. MADDALOZZO, Luis NT
5. COELHO, Lucas NSW
7. THORN LANGELAAR, Lukas NT
7. EAMES, Dylan QLD

Repechage

Loser contest **x** will appear at **x** in repechage

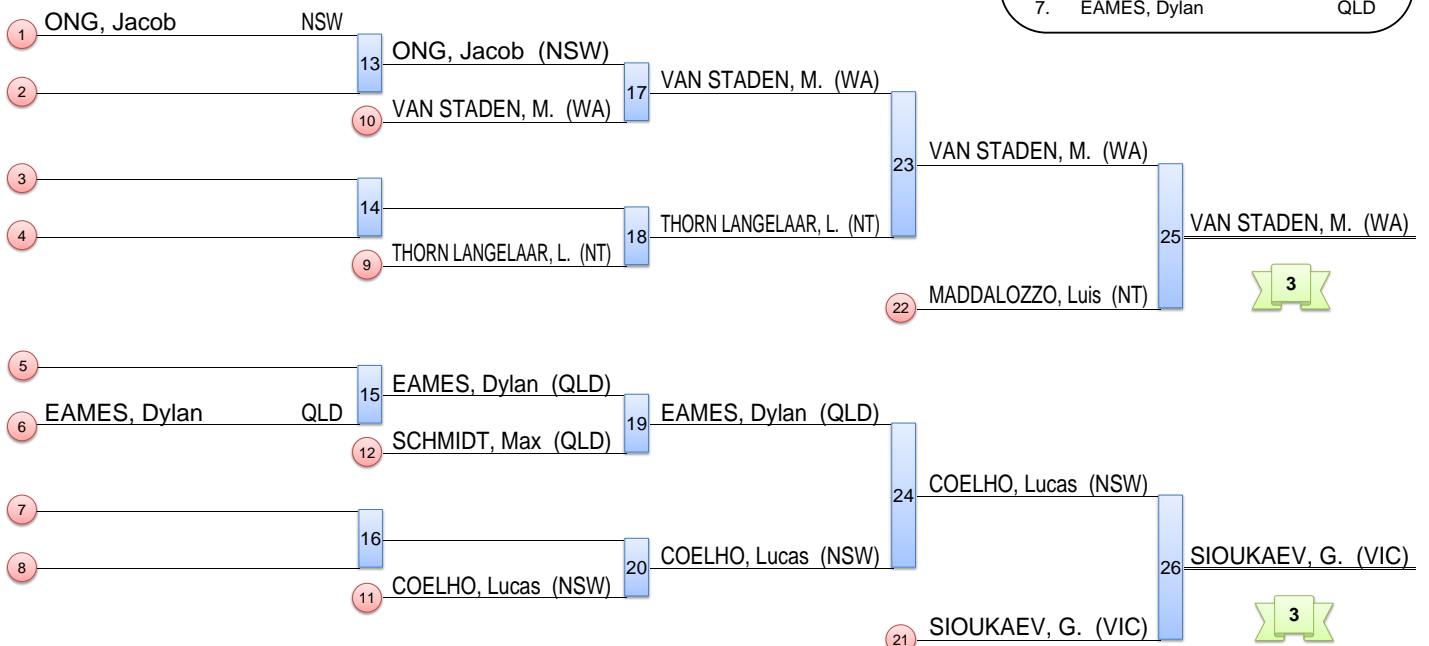

2022 Senior Boys and Girls Australian National Championships

Gold Coast (AUS), 11 Jun 2022

-66 kg

6 Judoka

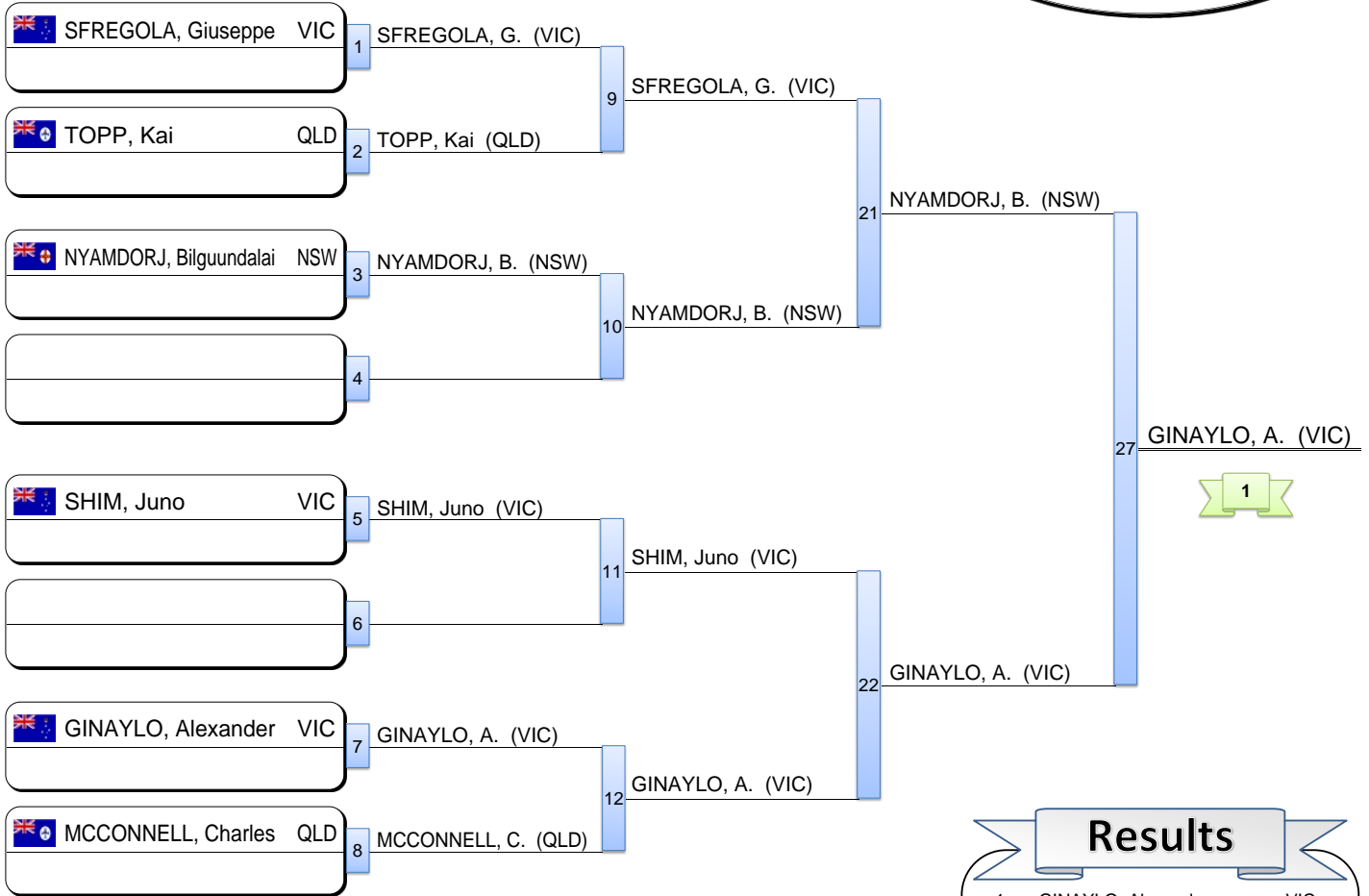

Results

1. GINAYLO, Alexander VIC
2. NYAMDORJ, Bilguundalai NSW
3. TOPP, Kai QLD
3. SFREGOLA, Giuseppe VIC
5. SHIM, Juno VIC
5. MCCONNELL, Charles QLD
- 7.
- 7.

Repechage

Loser contest **x** will appear at **x** in repechage

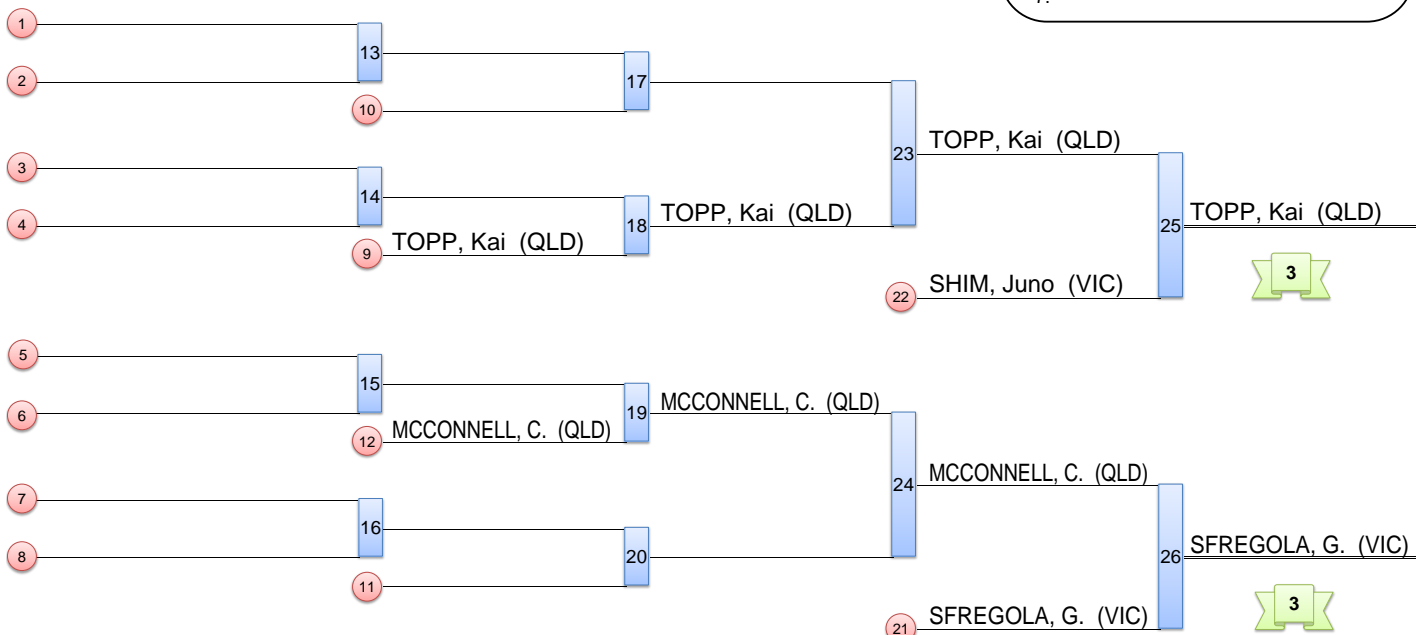

+66 kg

2 Judoka

BEST OF THREE

1	TAUMOEPEAU, Lisiate	ACT	1	GIBBS, Jimmy	VIC	00 / 10	0:56
2	GIBBS, Jimmy	VIC					

1	TAUMOEPEAU, Lisiate	ACT	2	GIBBS, Jimmy	VIC	00 / 10	0:31
2	GIBBS, Jimmy	VIC					

1	TAUMOEPEAU, Lisiate	ACT	3	GIBBS, Jimmy	VIC		
2	GIBBS, Jimmy	VIC					

Final Results

1. GIBBS, Jimmy VIC
2. TAUMOEPEAU, Lisiate ACT

2022 Cadet Men and Women Australian National Championships

Gold Coast (AUS), 12 Jun 2022

-44 kg

2 Judoka

BEST OF THREE

1	ANDERSON, Nanami	QLD	1	ANDERSON, Nanami	QLD
2	LIAO, Jaeda	NSW		10 s1 / 00 s2	2:23

1	ANDERSON, Nanami	QLD	2	ANDERSON, Nanami	QLD
2	LIAO, Jaeda	NSW		10 s2 / 00 s2	2:54

1	ANDERSON, Nanami	QLD	3		
2	LIAO, Jaeda	NSW			

Final Results

- 1.
- 2.

2022 Cadet Men and Women Australian National Championships

Gold Coast (AUS), 12 Jun 2022

-48 kg

4 Judoka

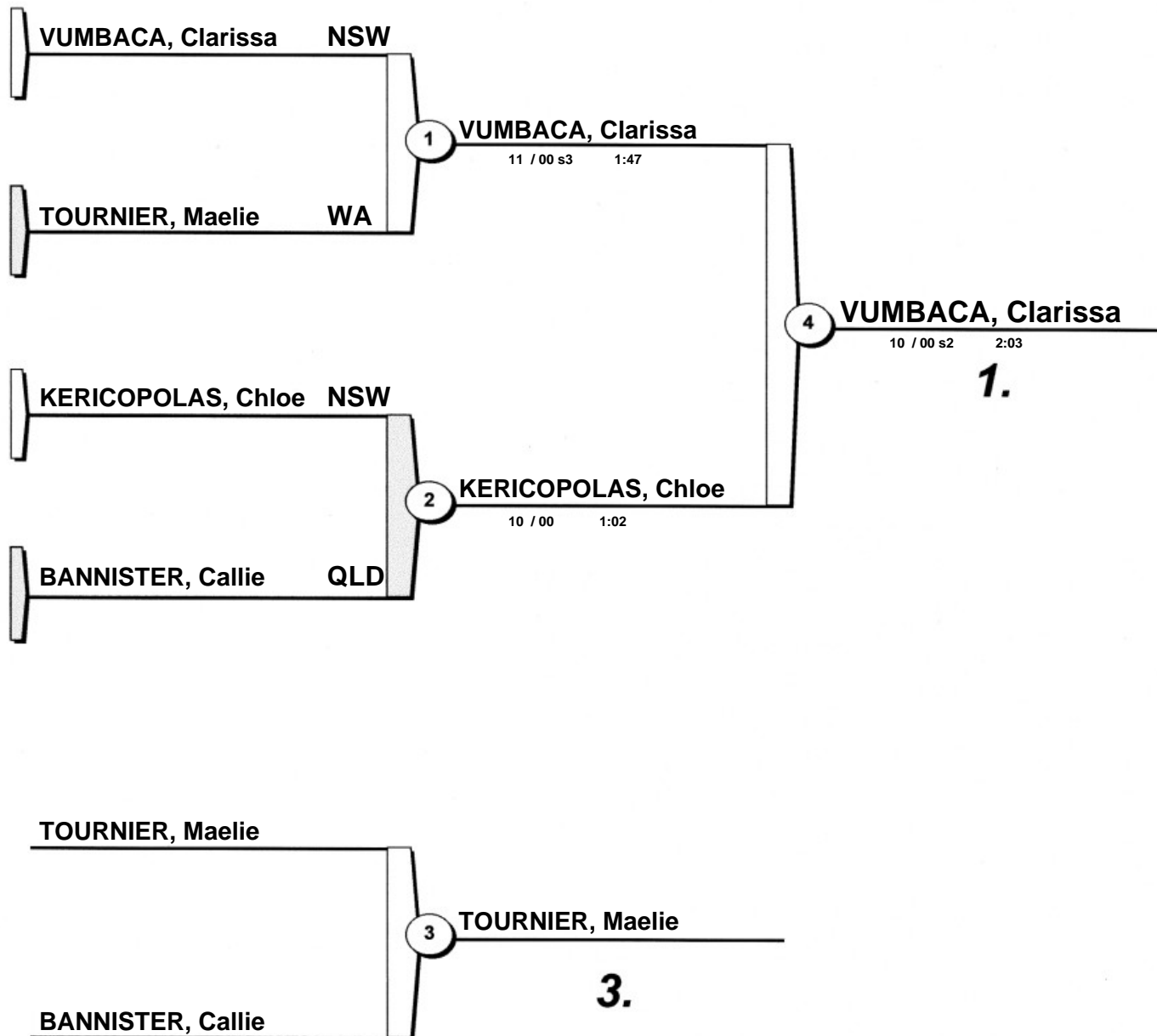

Final Results

1. VUMBACA, Clarissa NSW
2. KERICOPOLAS, Chloe NSW
3. TOURNIER, Maelie WA

-52 kg

2 Judoka

BEST OF THREE

1	BLACK, Jada	QLD	1	FIELDER, Sienna	QLD	00 s2 / 01 s2	4:00
2	FIELDER, Sienna	QLD					

1	BLACK, Jada	QLD	2	FIELDER, Sienna	QLD	00 sH / 10	1:53
2	FIELDER, Sienna	QLD					

1	BLACK, Jada	QLD	3	FIELDER, Sienna	QLD		
2	FIELDER, Sienna	QLD					

Final Results

- 1.
- 2.

2022 Cadet Men and Women Australian National Championships

Gold Coast (AUS), 12 Jun 2022

-57 kg

14 Judoka

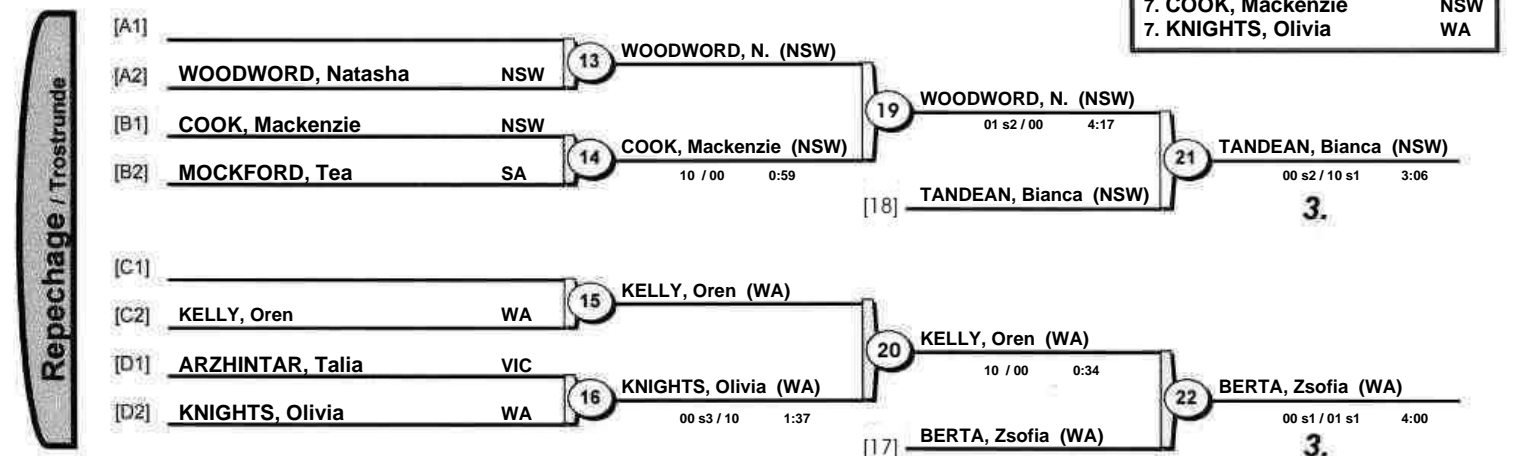
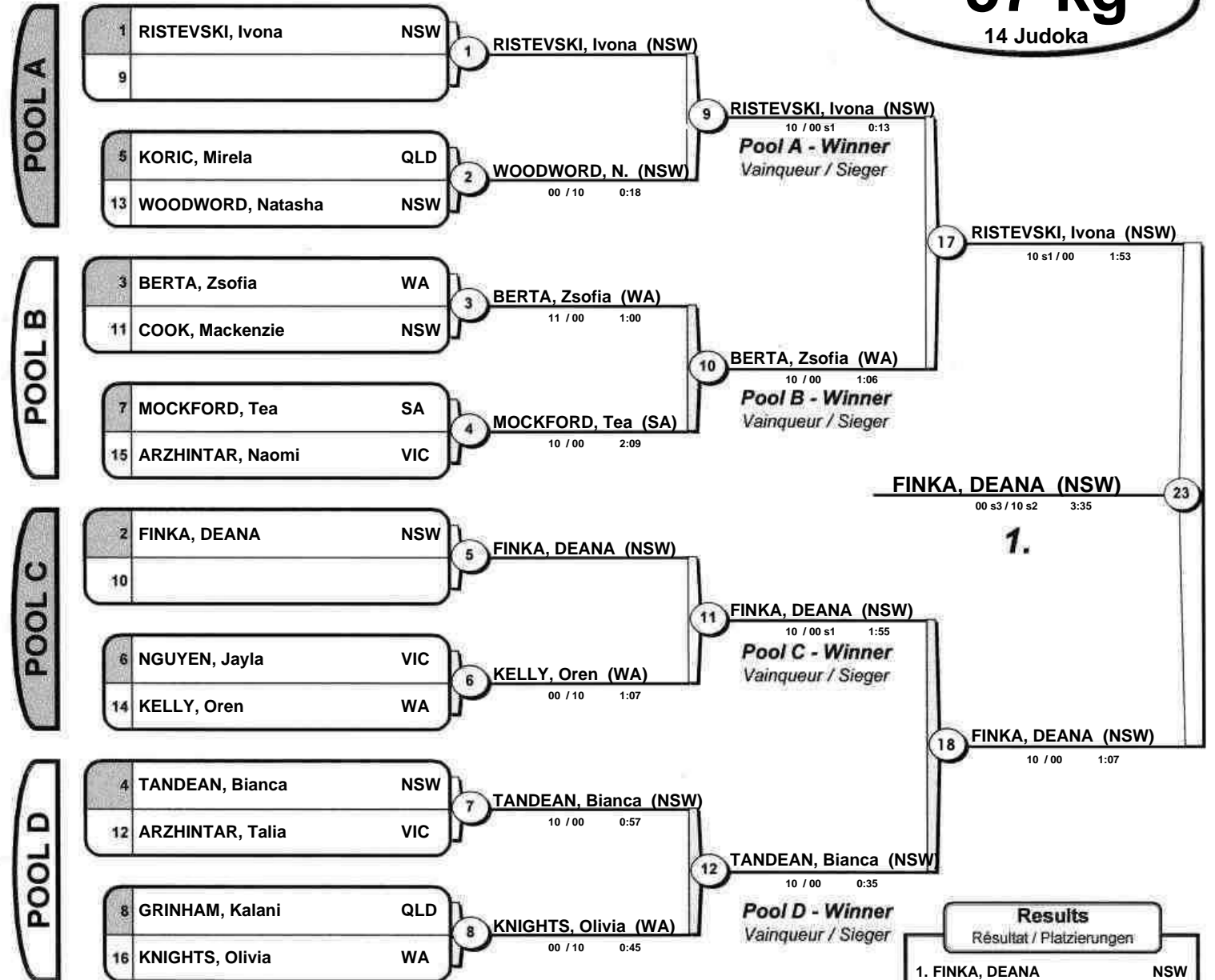

2022 Cadet Men and Women Australian National Championships

Gold Coast (AUS), 12 Jun 2022

-63 kg

5 Judoka

			1	3	5	Wins Score	
1	GEVORGIAN, Jessie	ACT		0	0	0 0	
3	WOODWARD, Gabrielle	QLD	1		1	2 0	
5	LE, Yen	VIC	1	0		1 0	

			2	4	Wins	Scores
2	BODIROZA, Andjela	NSW		0		(0)
4	MAYER, Abigail	VIC	1			(0)

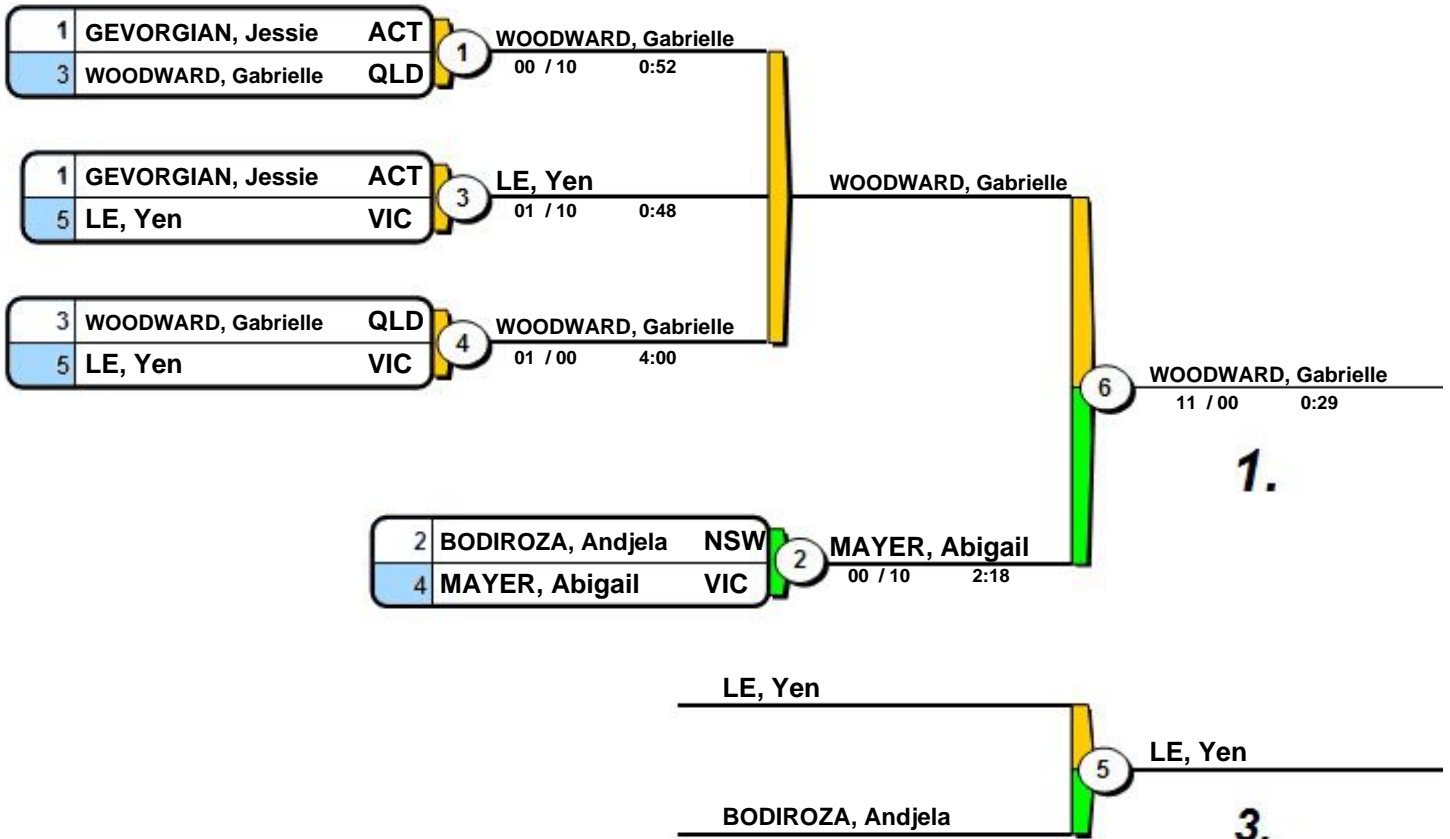

Final Results

1. WOODWARD, Gabrielle QLD
2. MAYER, Abigail VIC
3. LE, Yen VIC

2022 Cadet Men and Women Australian National Championships

Gold Coast (AUS), 12 Jun 2022

-70 kg

6 Judoka

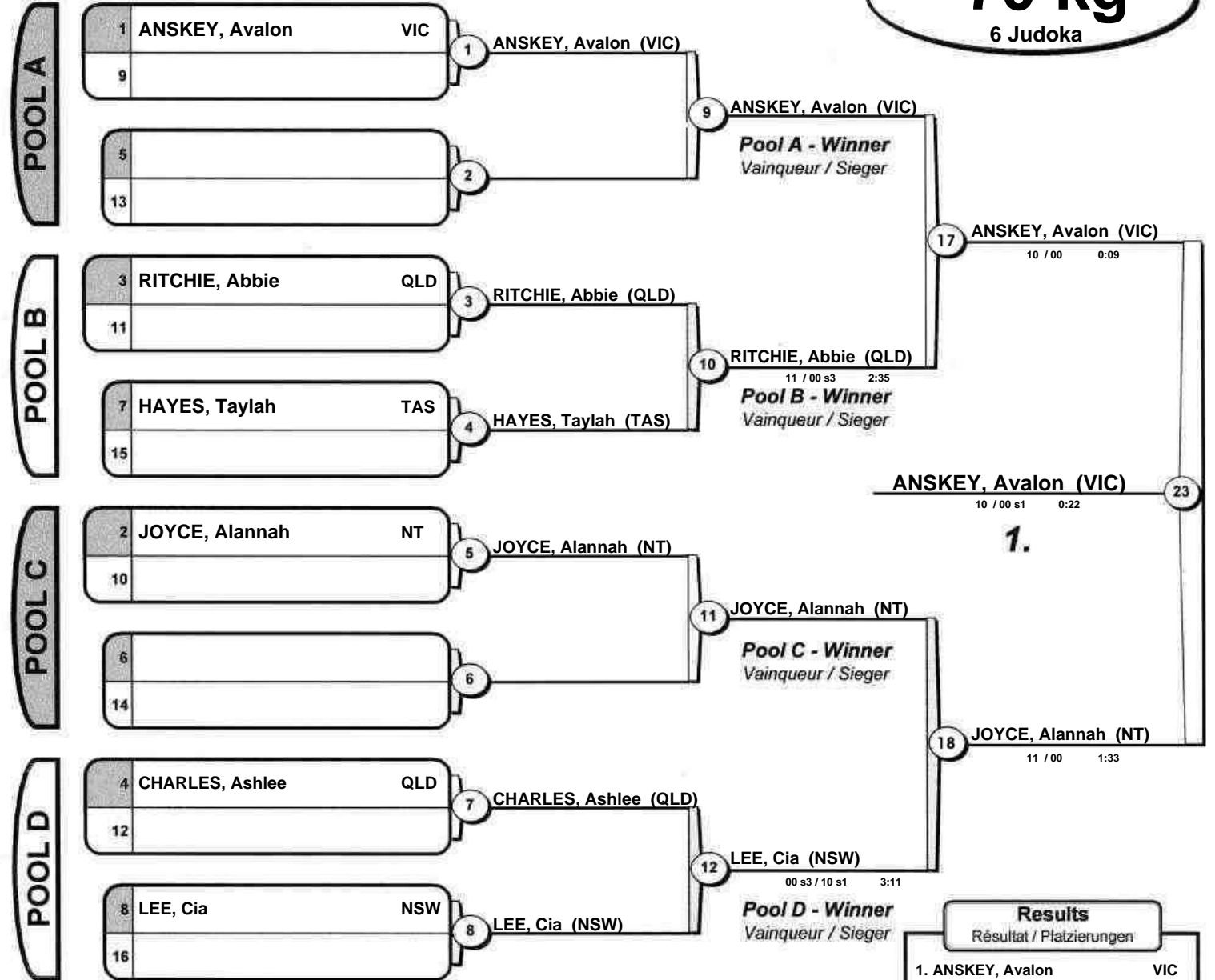

Results	
Résultat / Platzierungen	
1.	ANSKEY, Avalon VIC
2.	JOYCE, Alannah NT
3.	LEE, Cia NSW
3.	RITCHIE, Abbie QLD
5.	HAYES, Taylah TAS
5.	CHARLES, Ashlee QLD
7.	
7.	

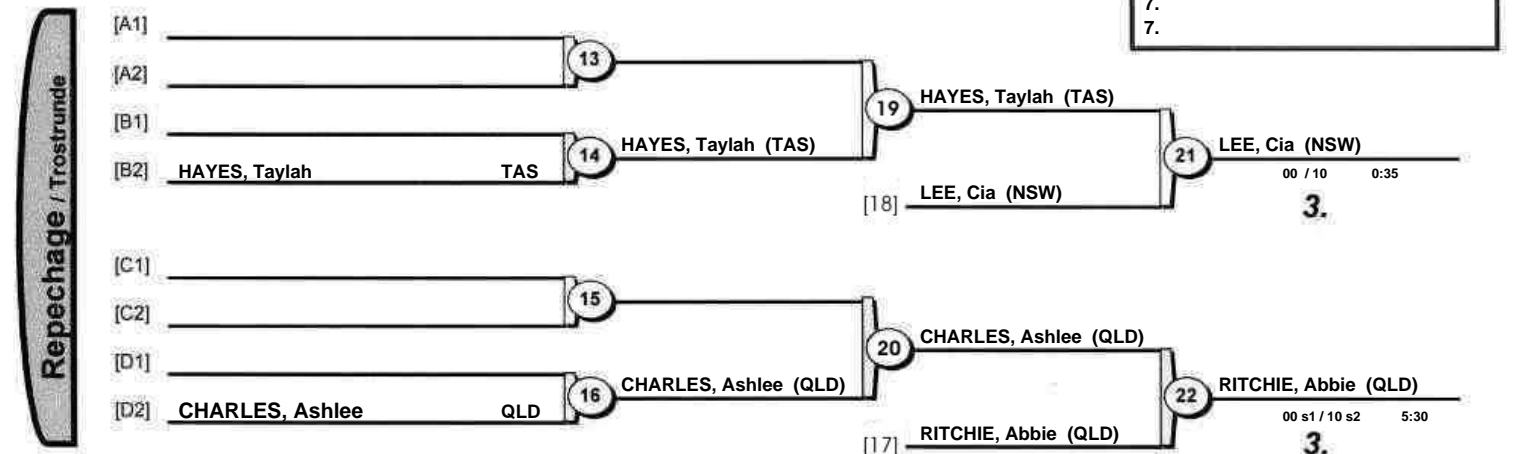

+70 kg

2 Judoka

BEST OF THREE

1	YANG, Shaoxuan	NSW	1	SAZDOV, Mia	VIC	00 / 11	1:08
2	SAZDOV, Mia	VIC					

1	YANG, Shaoxuan	NSW	2	SAZDOV, Mia	VIC	00 / 10	0:08
2	SAZDOV, Mia	VIC					

1	YANG, Shaoxuan	NSW	3				
2	SAZDOV, Mia	VIC					

Final Results

- 1.
- 2.

2022 Cadet Men and Women Australian National Championships

Gold Coast (AUS), 12 Jun 2022

-50 kg

6 Judoka

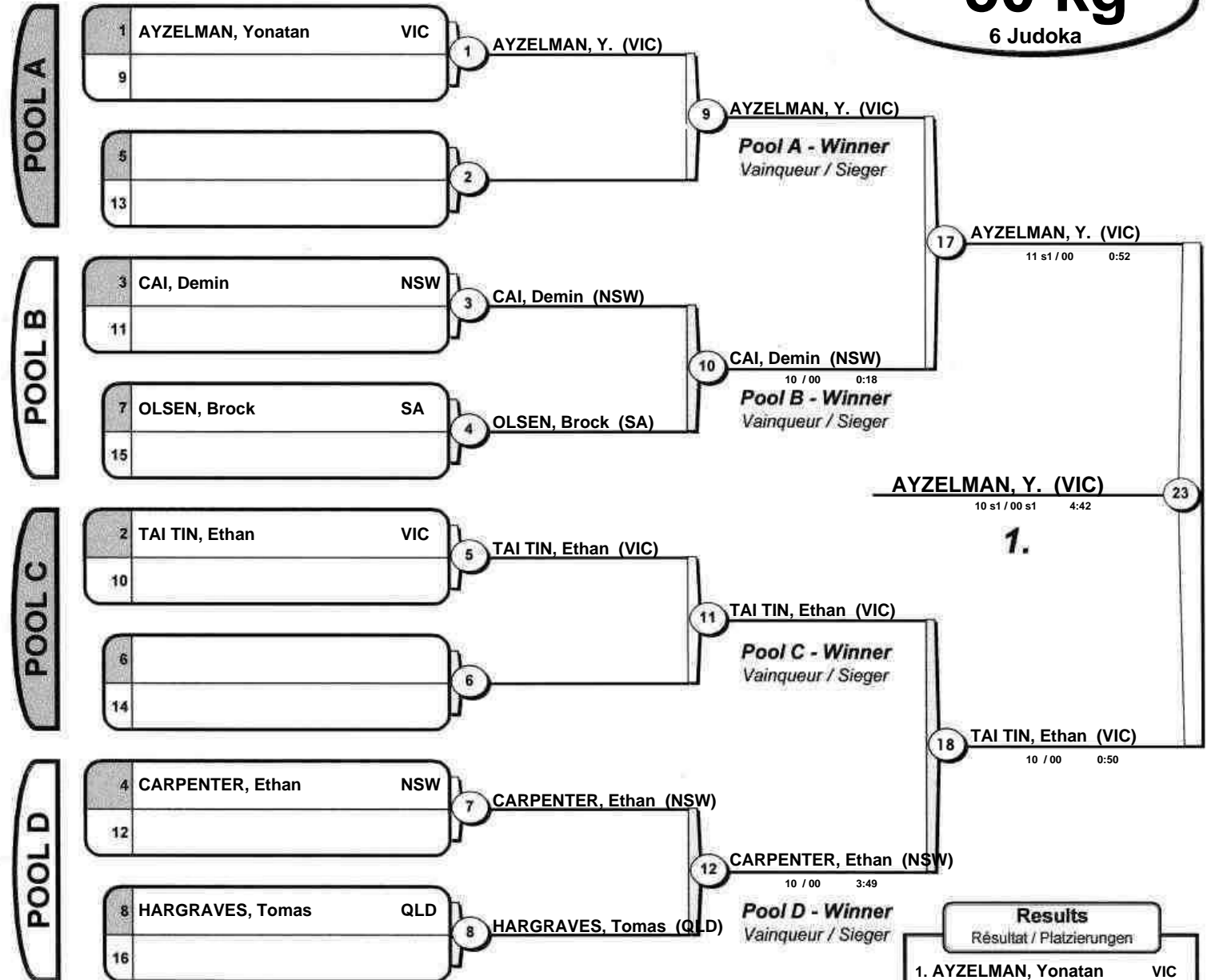

Results		
Résultat / Platzierungen		
1.	AYZELMAN, Yonatan	VIC
2.	TAI TIN, Ethan	VIC
3.	CARPENTER, Ethan	NSW
3.	HARGRAVES, Tomas	QLD
5.	OLSEN, Brock	SA
5.	CAI, Demin	NSW
7.		
7.		

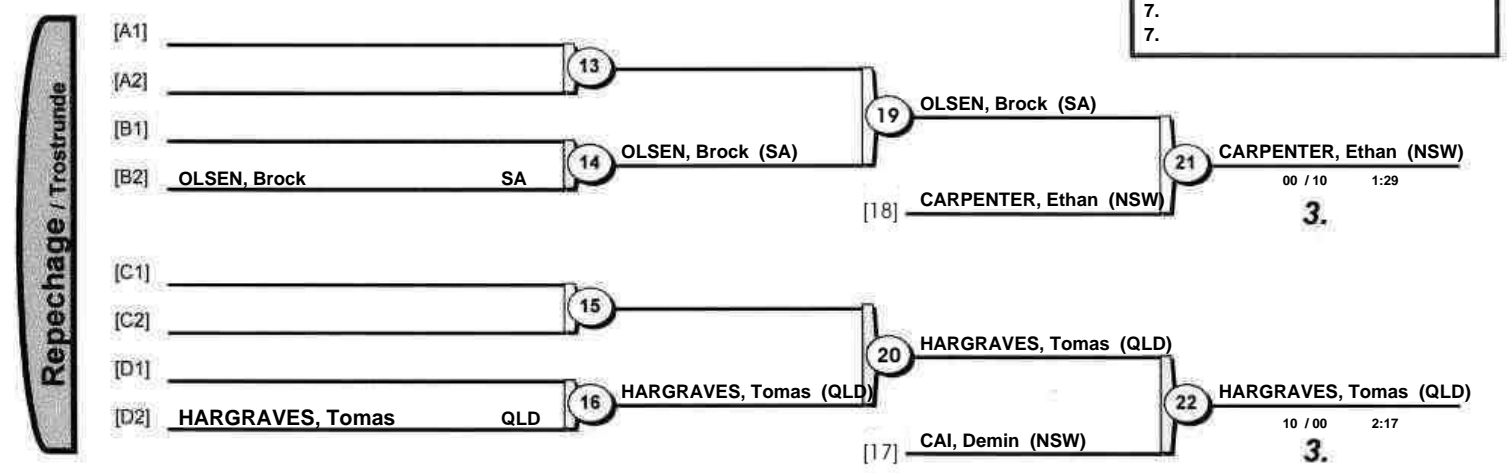

2022 Cadet Men and Women Australian National Championships

Gold Coast (AUS), 12 Jun 2022

-55 kg

13 Judoka

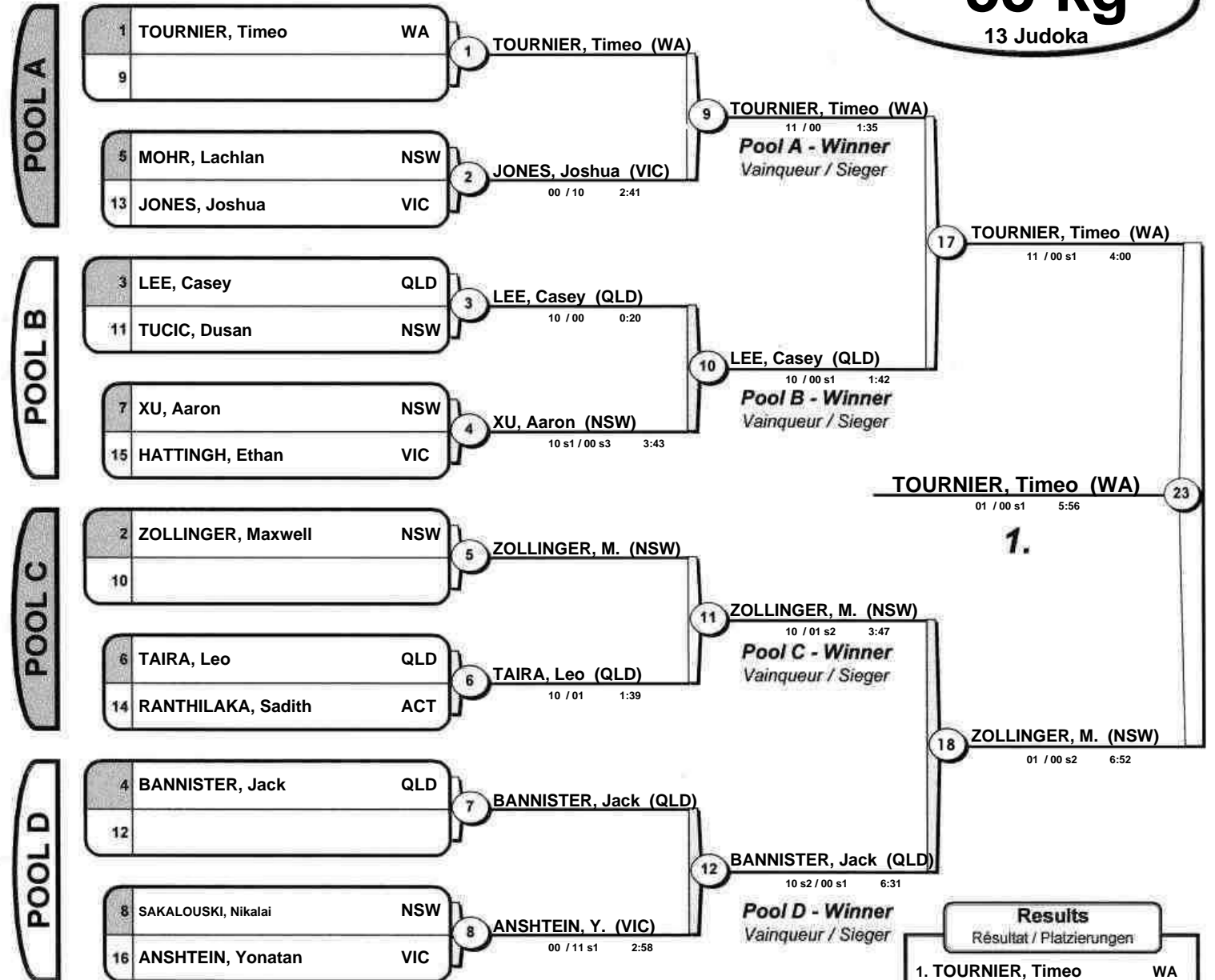

TOURNIER, Timeo (WA)
01 / 00 s1 5:56
1.

Results		
Résultat / Platzierungen		
1.	TOURNIER, Timeo	WA
2.	ZOLLINGER, Maxwell	NSW
3.	BANNISTER, Jack	QLD
3.	ANSHTEIN, Yonatan	VIC
5.	JONES, Joshua	VIC
5.	LEE, Casey	QLD
7.	XU, Aaron	NSW
7.	TAIRA, Leo	QLD

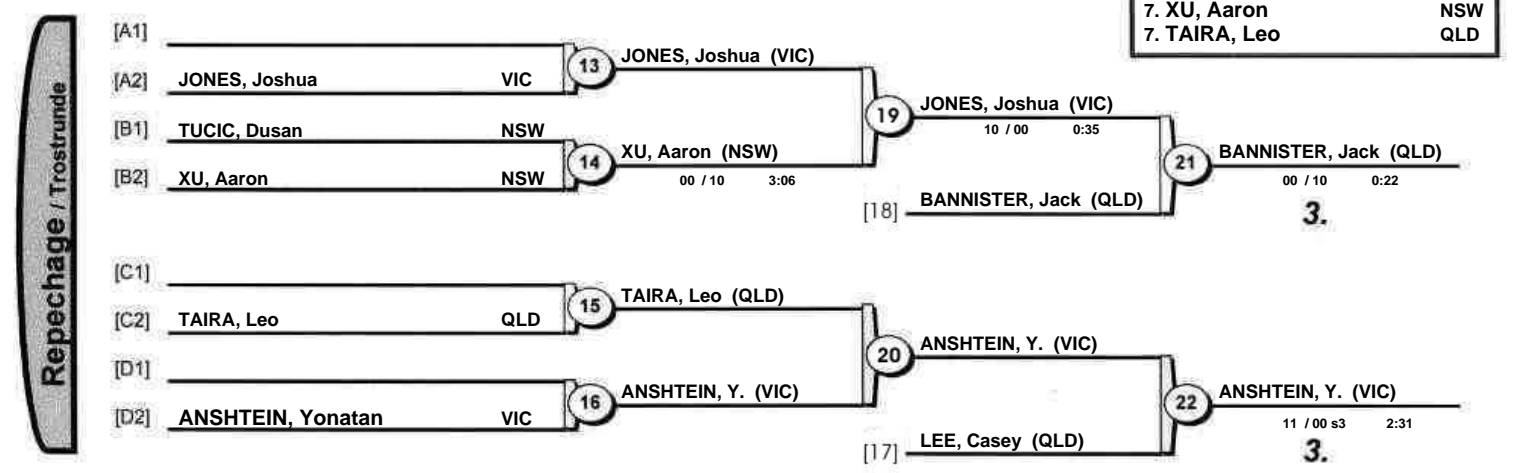

2022 Cadet Men and Women Australian National Championships

Gold Coast (AUS), 12 Jun 2022

-60 kg

13 Judoka

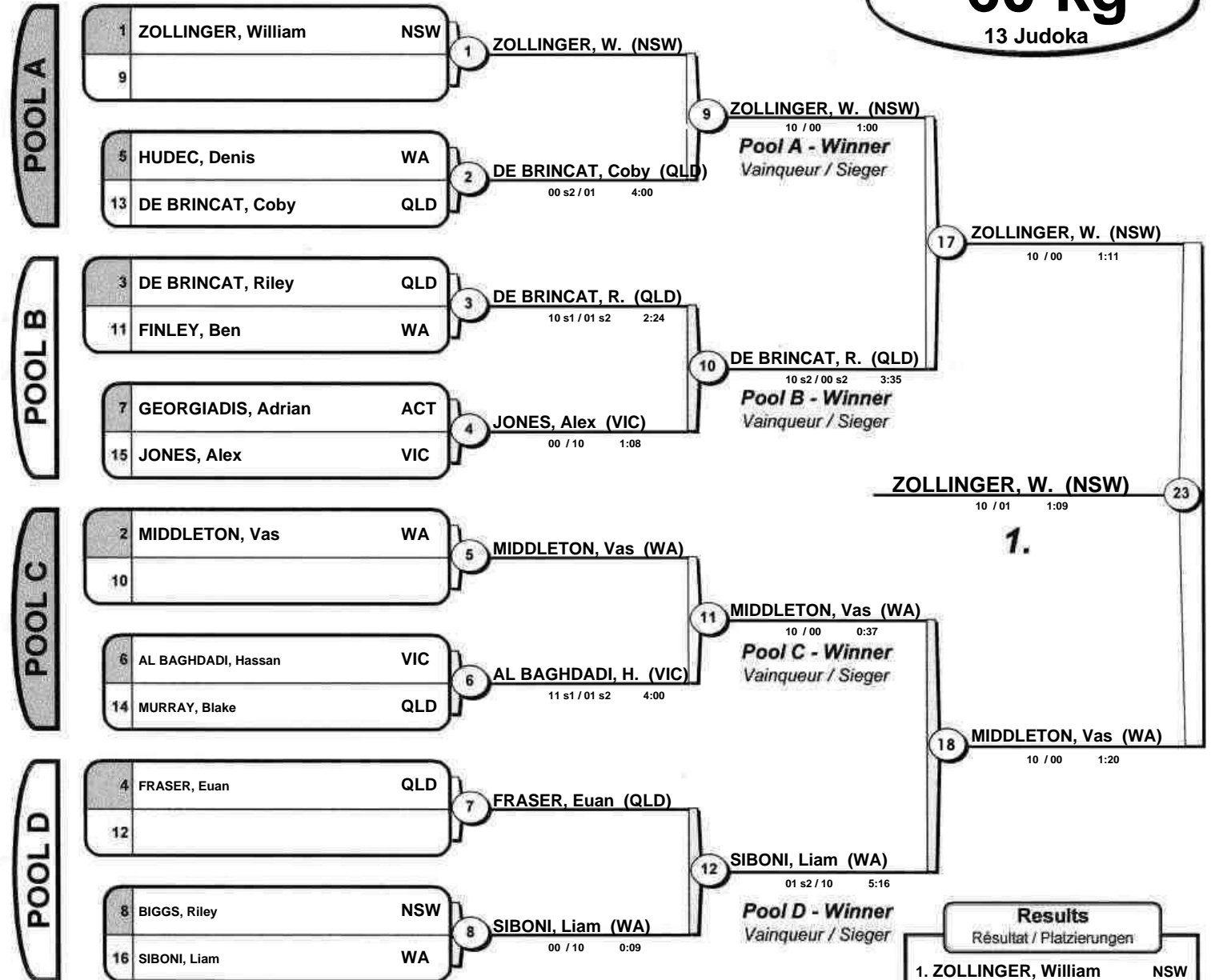

Results	
Résultat / Platzierungen	
1.	ZOLLINGER, William NSW
2.	MIDDLETON, Vas WA
3.	SIBONI, Liam WA
3.	DE BRINCAT, Riley QLD
5.	DE BRINCAT, Coby QLD
5.	AL BAGHDADI, Hassan VIC
7.	FINLEY, Ben WA
7.	FRASER, Euan QLD

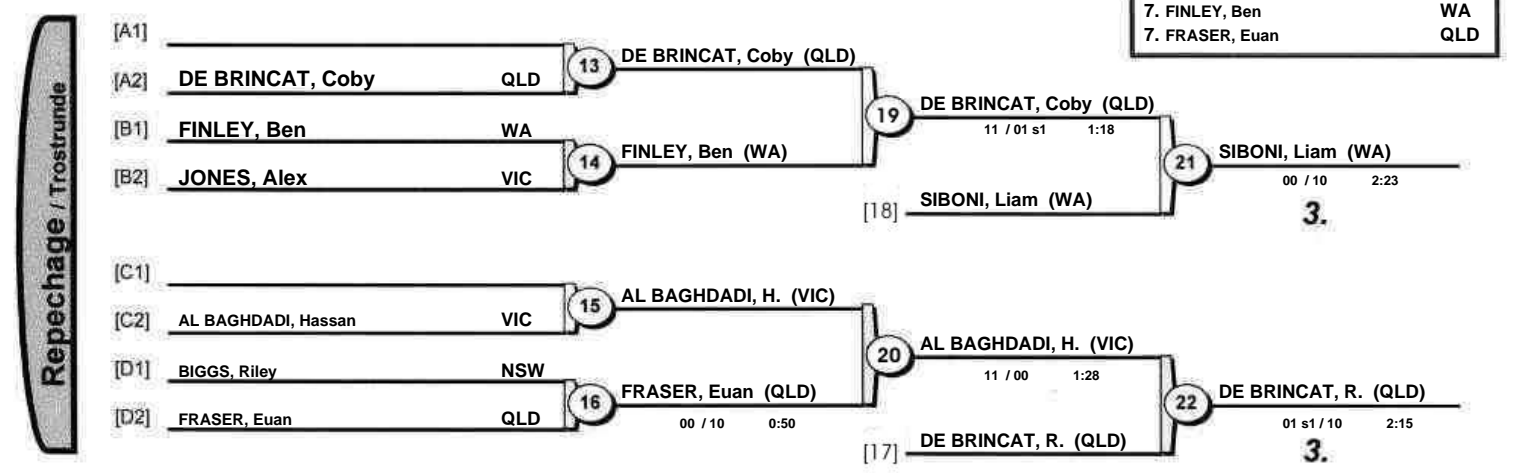

2022 Cadet Men and Women Australian National Championships

Gold Coast (AUS), 12 Jun 2022

-66 kg

20 Judoka

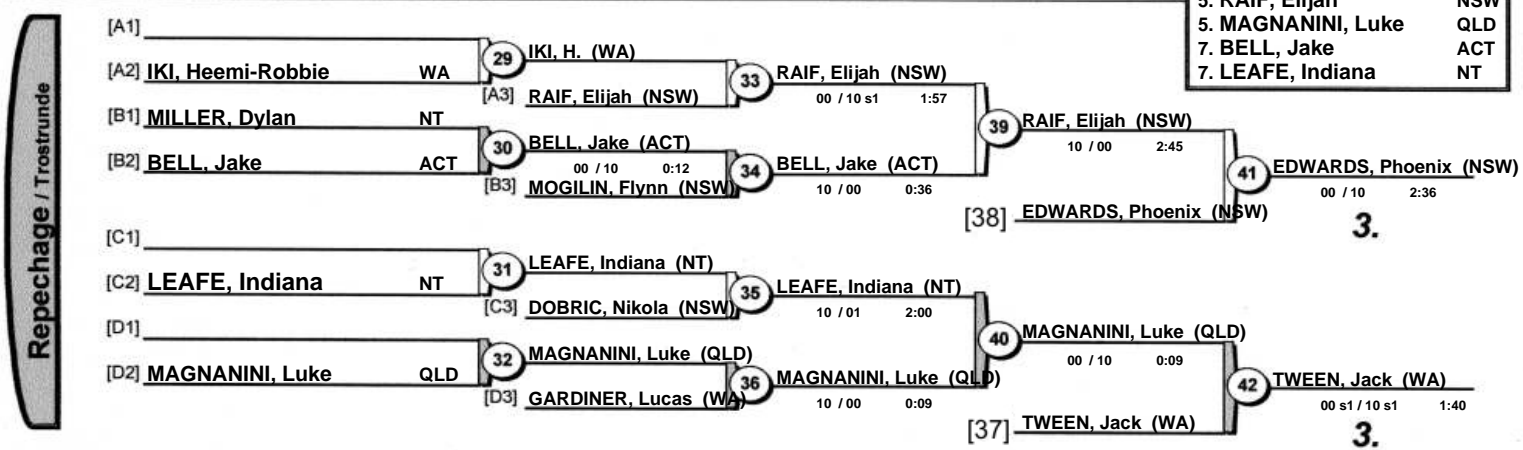
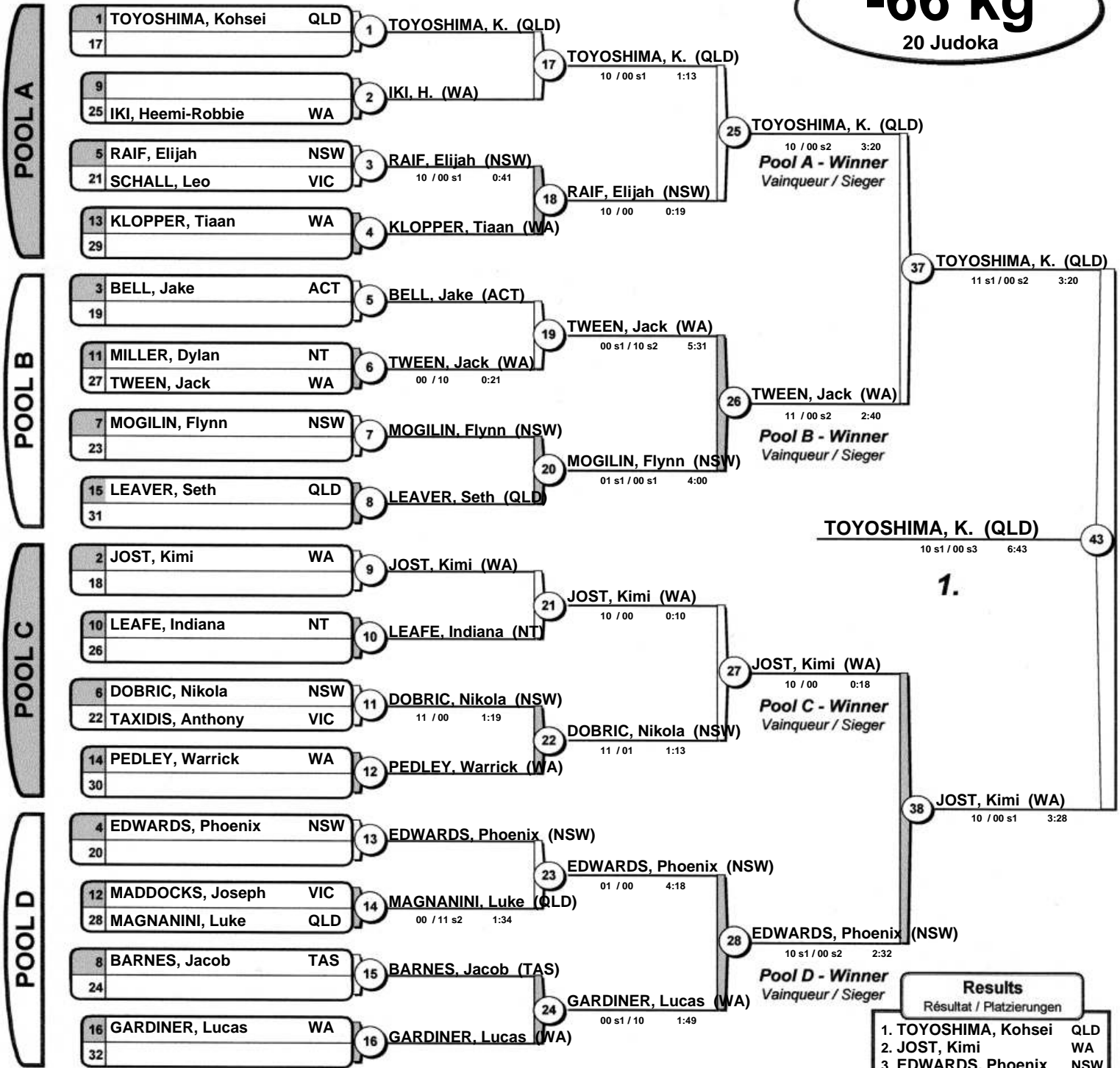

2022 Cadet Men and Women Australian National Championships

Gold Coast (AUS), 12 Jun 2022

-73 kg

14 Judoka

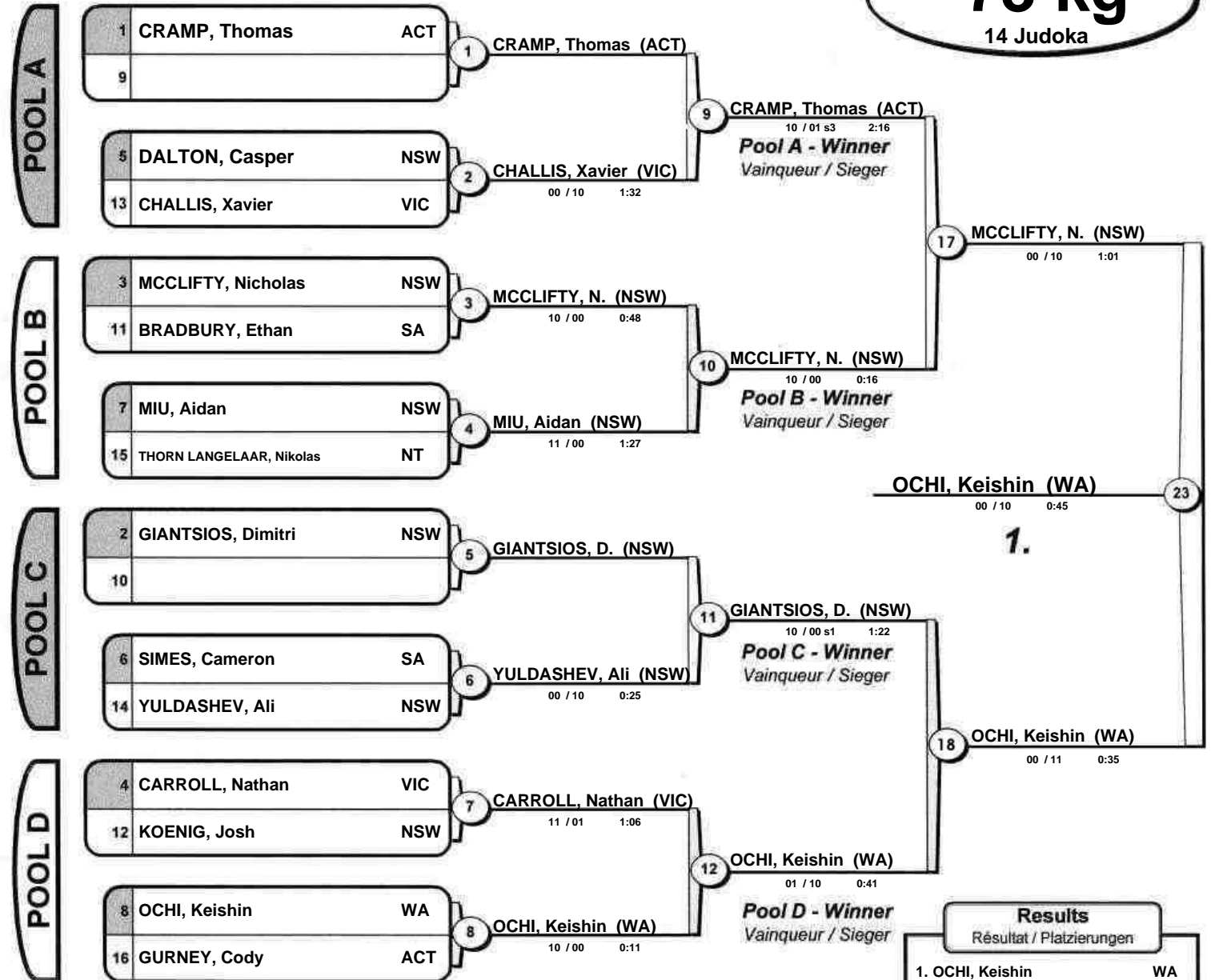

Results	
Résultat / Platzierungen	
1. OCHI, Keishin	WA
2. MCCLIFTY, Nicholas	NSW
3. GIANTSIOS, Dimitri	NSW
3. CRAMP, Thomas	ACT
5. MIU, Aidan	NSW
5. YULDASHEV, Ali	NSW
7. CHALLIS, Xavier	VIC
7. CARROLL, Nathan	VIC

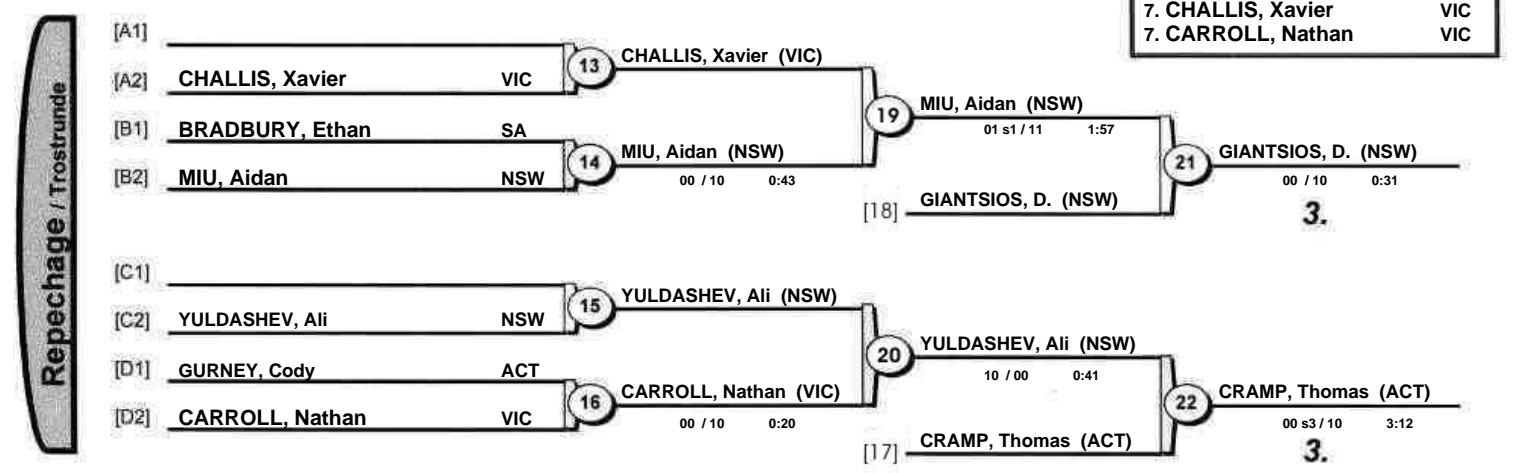

2022 Cadet Men and Women Australian National Championships

Gold Coast (AUS), 12 Jun 2022

-81 kg

7 Judoka

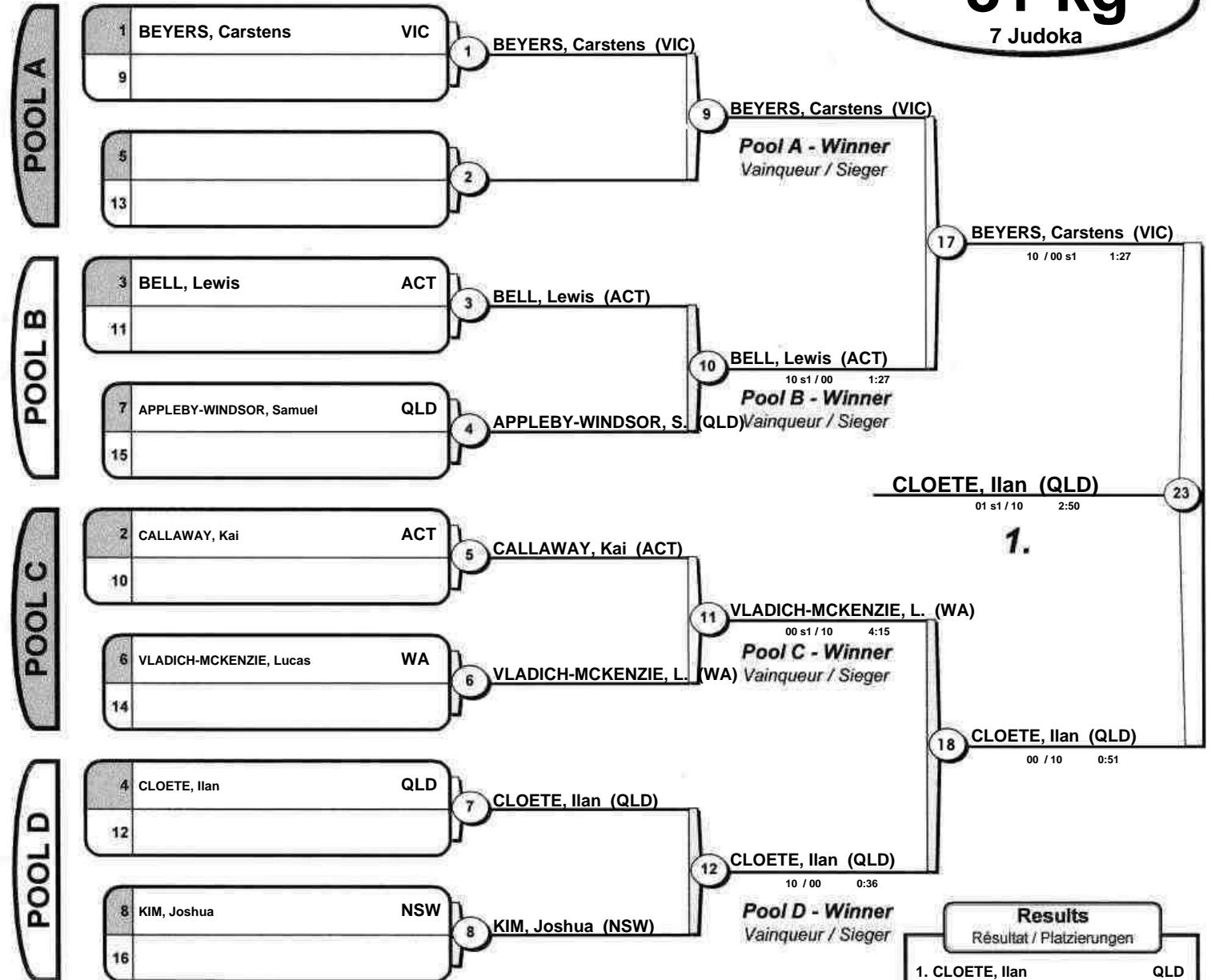

Results	
Résultat / Platzierungen	
1. CLOETE, Ilan	QLD
2. BEYERS, Carstens	VIC
3. APPLEBY-WINDSOR, Samuel	QLD
3. BELL, Lewis	ACT
5. VLADICH-MCKENZIE, Lucas	WA
5. CALLAWAY, Kai	ACT
7.	
7. KIM, Joshua	NSW

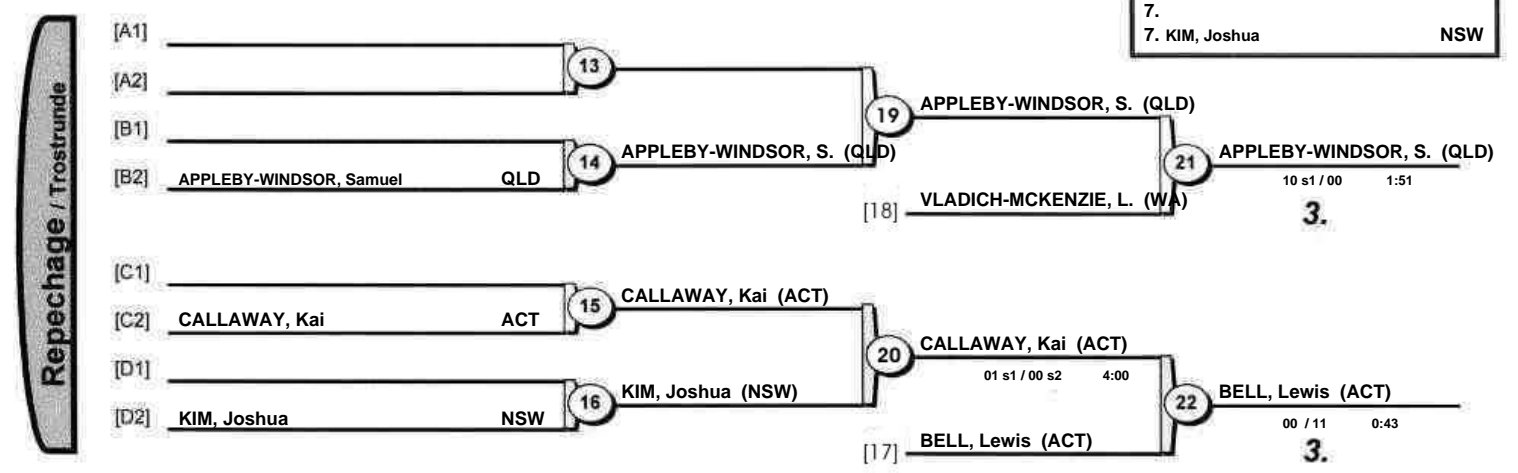

2022 Cadet Men and Women Australian National Championships

Gold Coast (AUS), 12 Jun 2022

-90 kg

4 Judoka

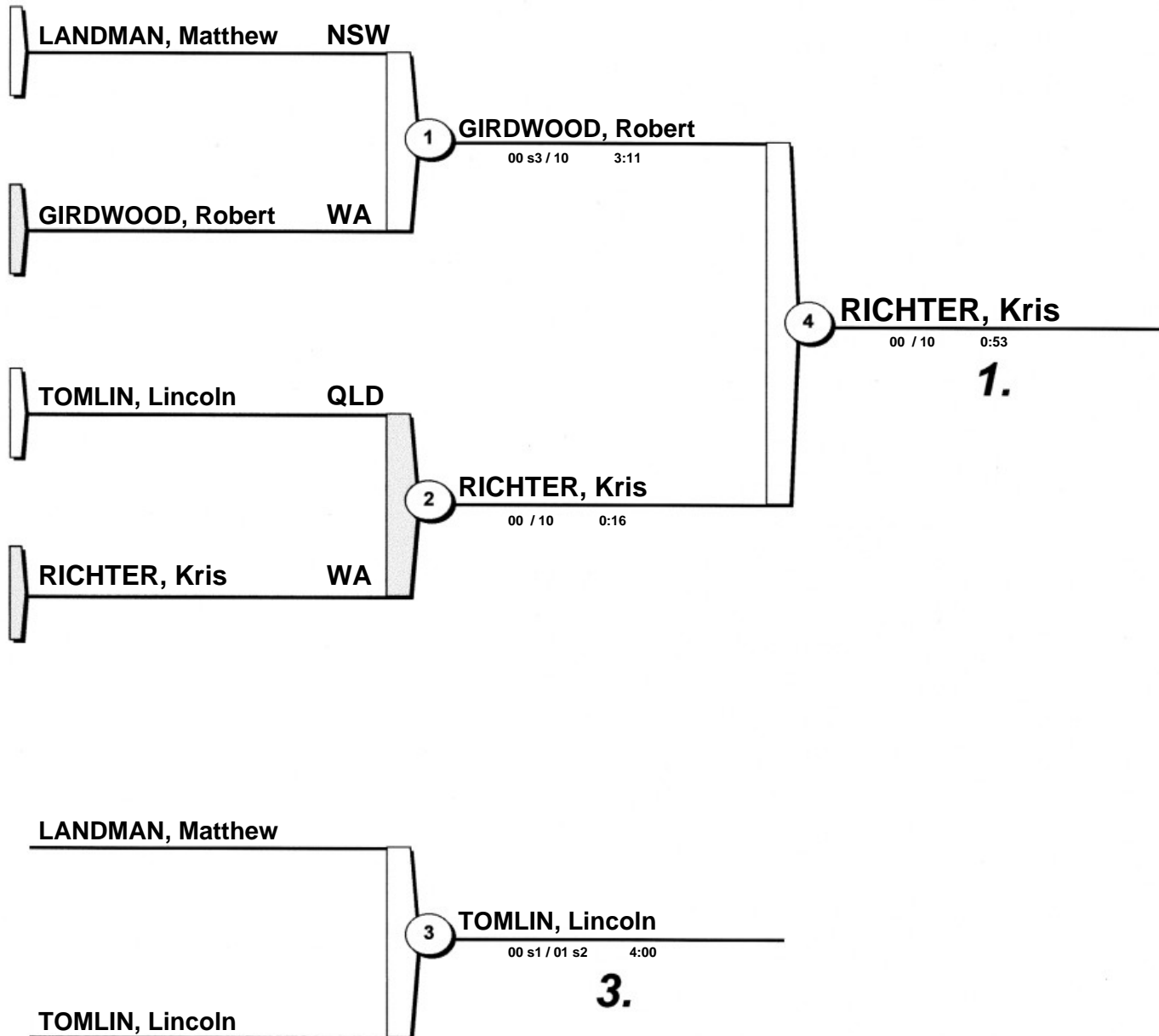

Final Results

- | | |
|---------------------|-----|
| 1. RICHTER, Kris | WA |
| 2. GIRDWOOD, Robert | WA |
| 3. TOMLIN, Lincoln | QLD |

2022 Cadet Men and Women Australian National Championships

Gold Coast (AUS), 12 Jun 2022

+90 kg

4 Judoka

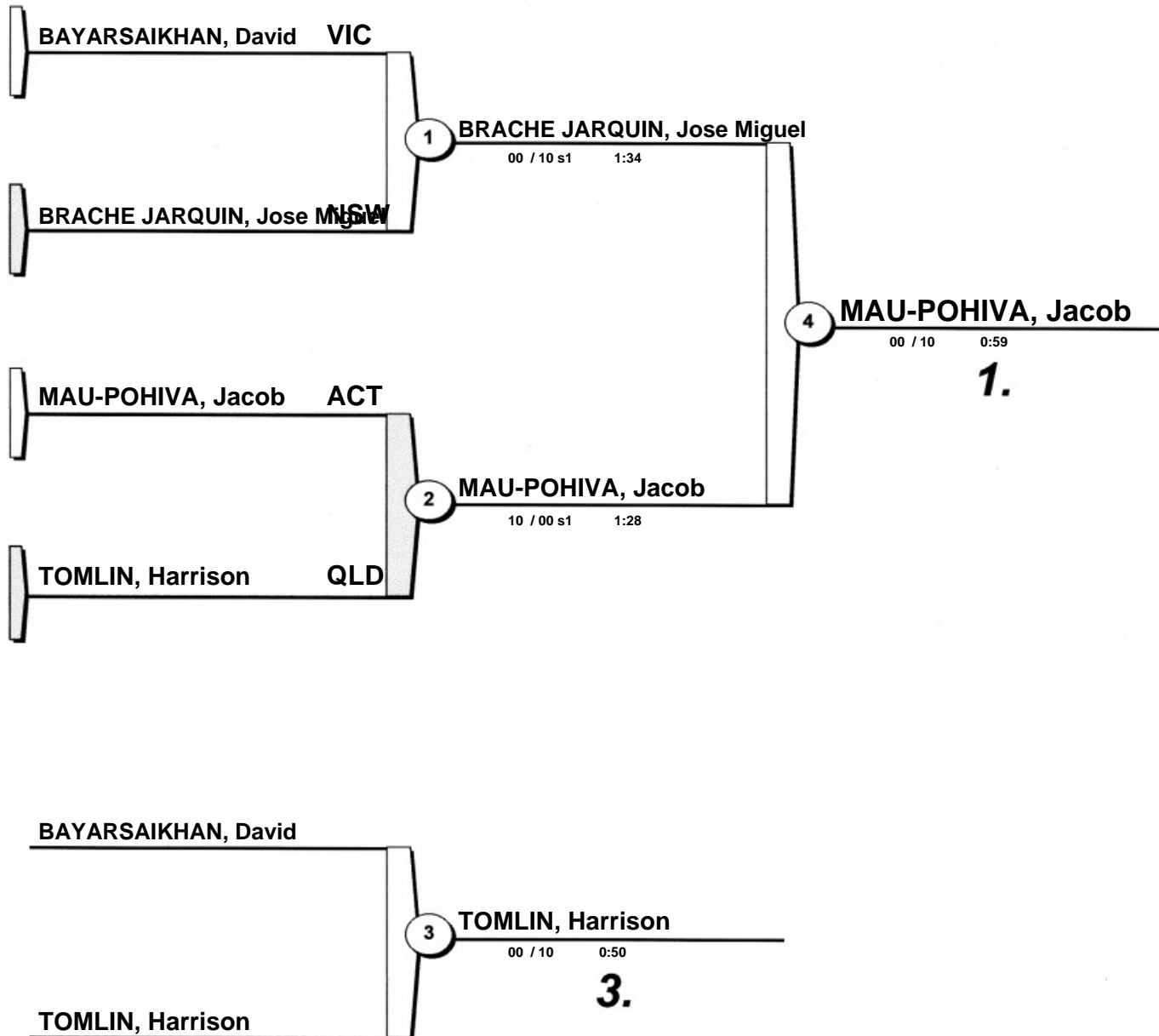

Final Results

1. MAU-POHIVA, Jacob ACT
2. BRACHE JARQUIN, Jose Miguel NSW
3. TOMLIN, Harrison QLD

2022 Junior Men and Women Australian National Championships

Gold Coast (AUS), 12 Jun 2022

-48 kg

8 Judoka

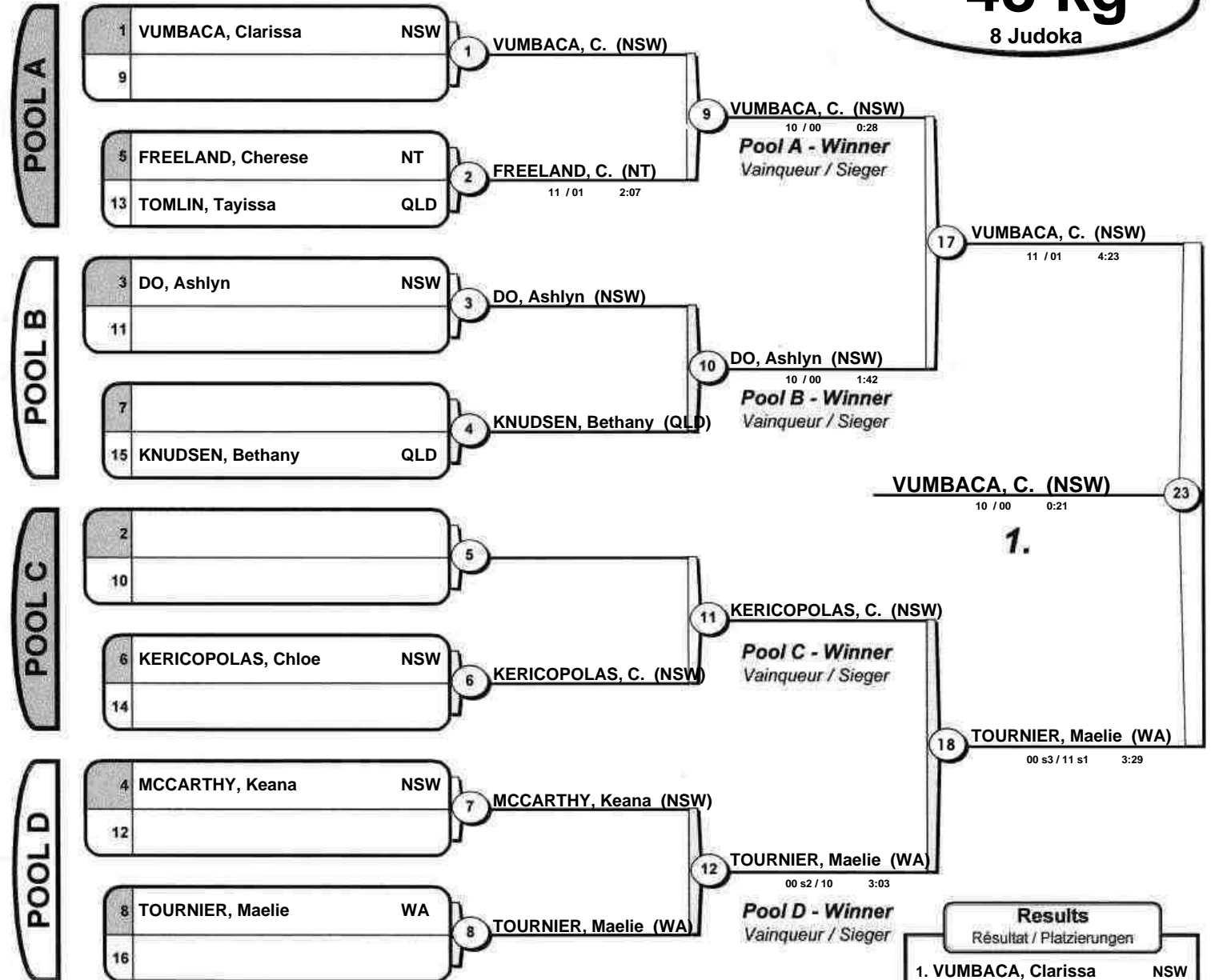

Results	
Résultat / Platzierungen	
1.	VUMBACA, Clarissa NSW
2.	TOURNIER, Maelie WA
3.	KERICOPOULAS, Chloe NSW
3.	DO, Ashlyn NSW
5.	FREELAND, Cherese NT
7.	MCCARTHY, Keana NSW
7.	KNUDSEN, Bethany QLD

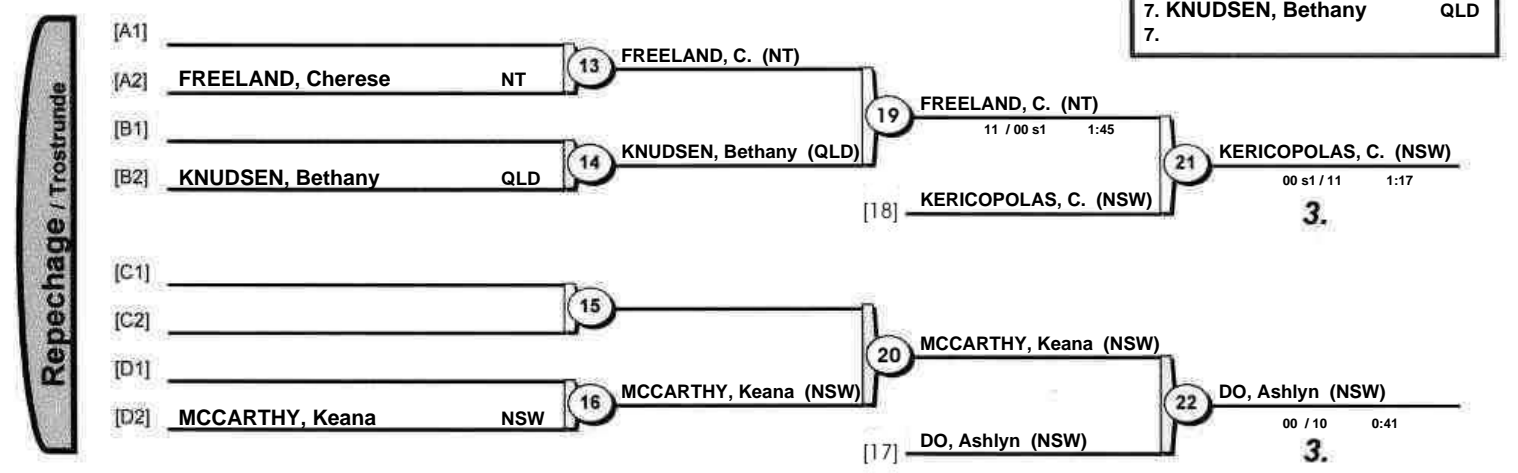

2022 Junior Men and Women Australian National Championships

Gold Coast (AUS), 12 Jun 2022

-52 kg

3 Judoka

			1	2	3	Wins Score	
1	FIELDER, Sienna	QLD		0	0	0 0	
2	FIELDER, Anneliese	QLD	1		1	2 0	
3	FRY, Alyssa	WA	1	0		1 0	

1	FIELDER, Sienna	QLD	1	FIELDER, Anneliese	QLD
2	FIELDER, Anneliese	QLD		00 s1 / 10	1:20

1	FIELDER, Sienna	QLD	2	FRY, Alyssa	WA
3	FRY, Alyssa	WA		00 / 10	0:12

2	FIELDER, Anneliese	QLD	3	FIELDER, Anneliese	QLD
3	FRY, Alyssa	WA		11 / 00 s1	2:47

Final Results

1. FIELDER, Anneliese QLD
2. FRY, Alyssa WA
- 3.

2022 Junior Men and Women Australian National Championships

Gold Coast (AUS), 12 Jun 2022

-57 kg

12 Judoka

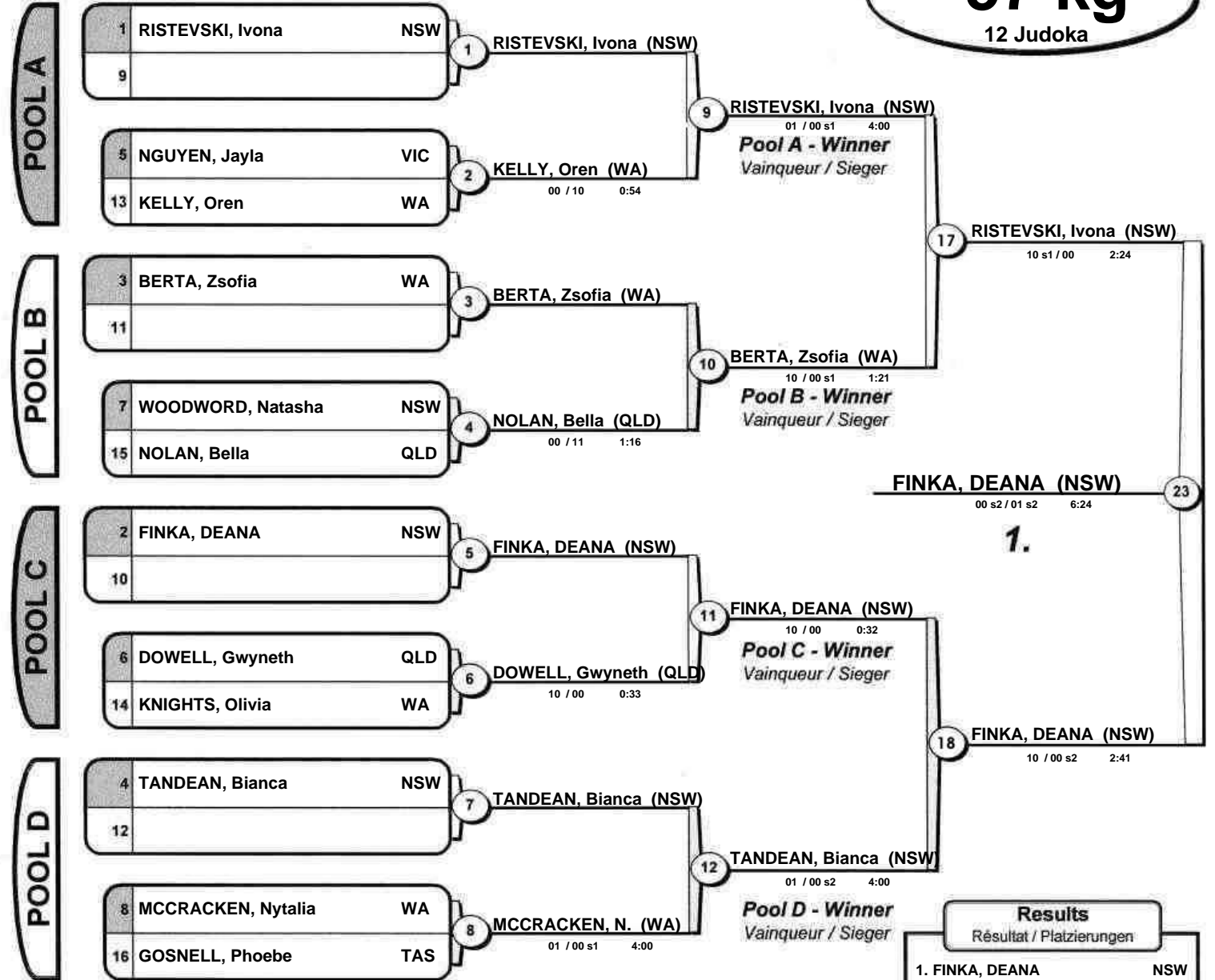

Results	
Résultat / Platzierungen	
1.	FINKA, DEANA (NSW)
2.	RISTEVSKI, Ivona (NSW)
3.	TANDEAN, Bianca (NSW)
3.	BERTA, Zsafia (WA)
5.	KELLY, Oren (WA)
5.	DOWELL, Gwyneth (QLD)
7.	NOLAN, Bella (QLD)
7.	MCCRACKEN, Nyalia (WA)

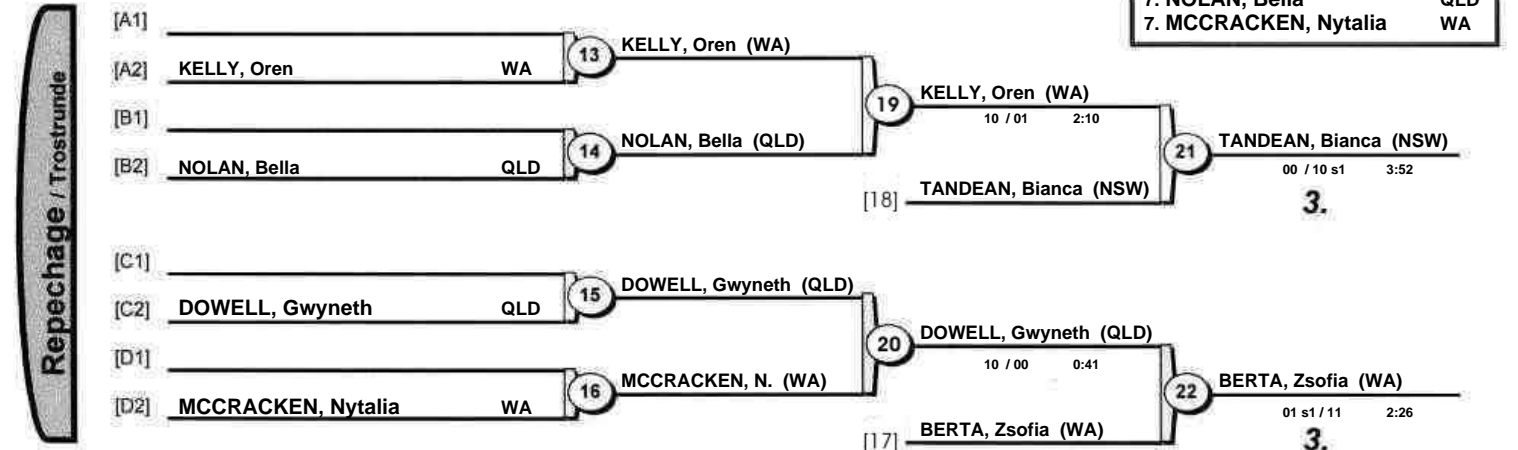

2022 Junior Men and Women Australian National Championships

Gold Coast (AUS), 12 Jun 2022

-60 kg

20 Judoka

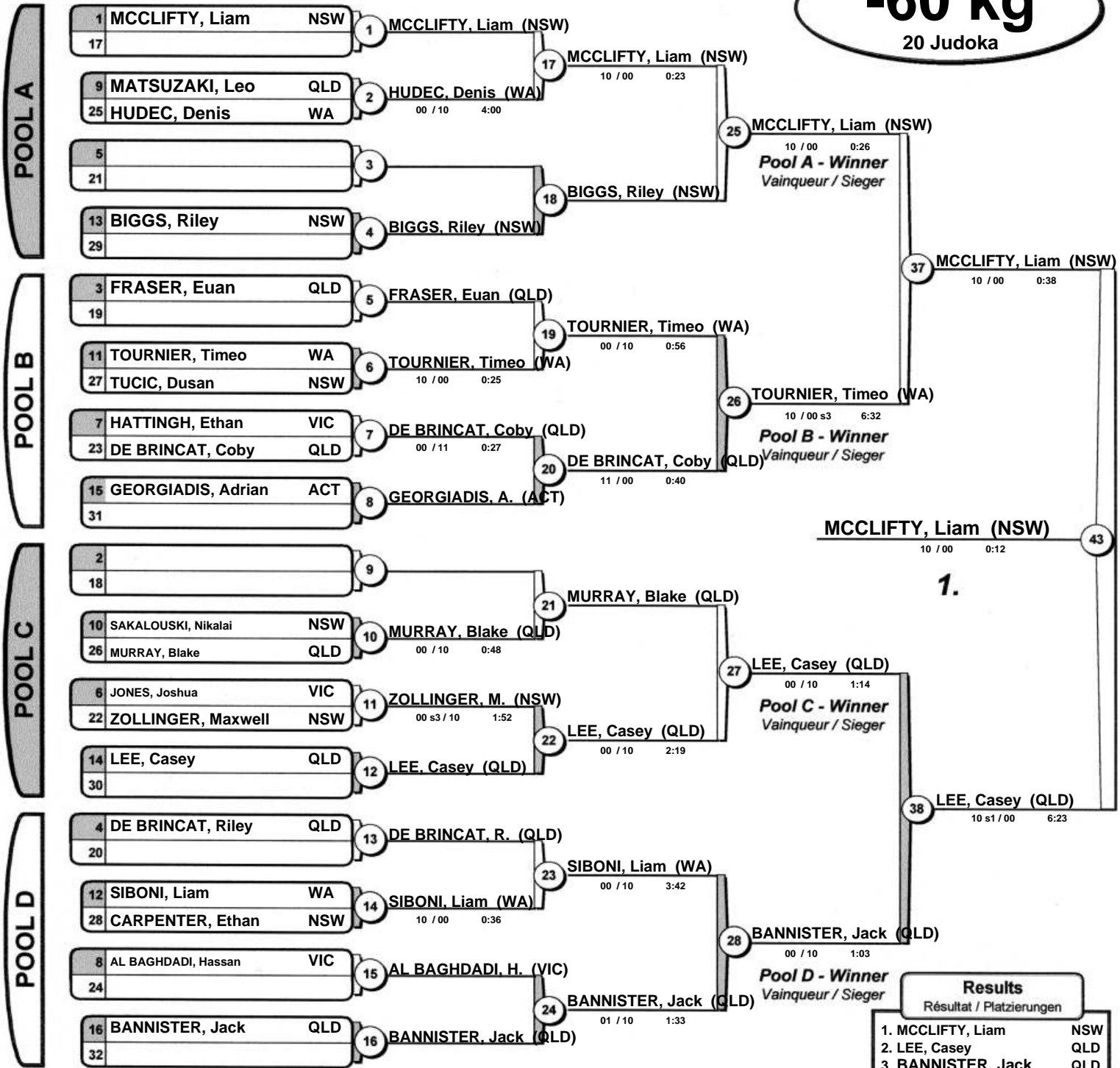

Results	
Résultat / Platzierungen	
1.	MCCLIFTY, Liam NSW
2.	LEE, Casey QLD
3.	BANNISTER, Jack QLD
4.	TOURNIER, Timeo WA
5.	HUDEC, Denis WA
6.	ZOLLINGER, Maxwell NSW
7.	DE BRINGCAT, Coby QLD
7.	SIBONI, Liam WA

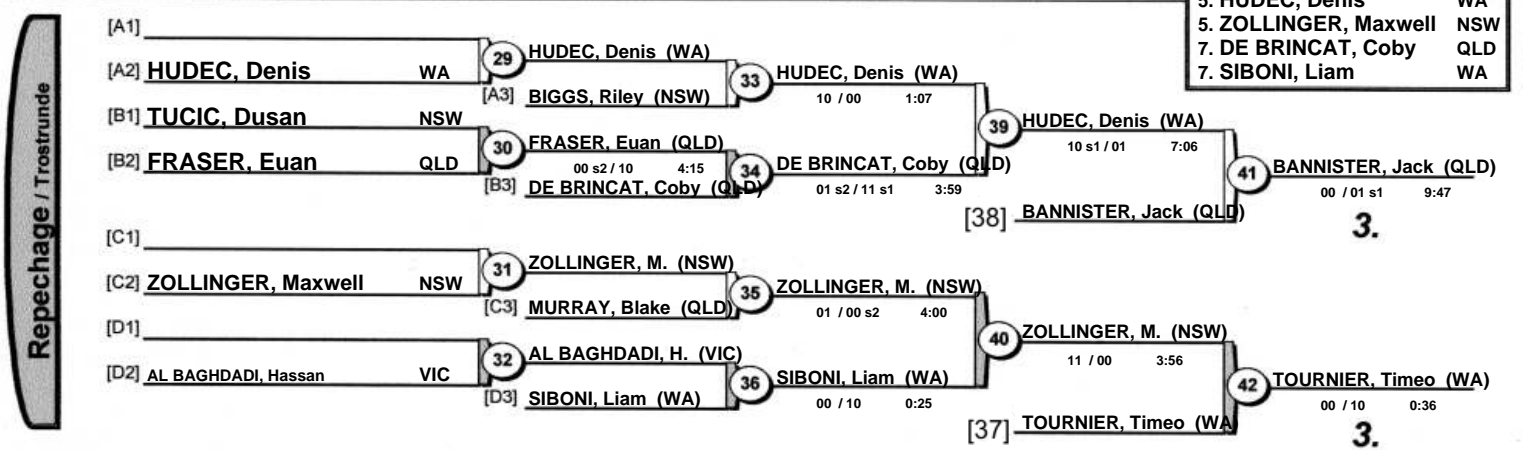

2022 Junior Men and Women Australian National Championships

Gold Coast (AUS), 12 Jun 2022

-63 kg

3 Judoka

			1	2	3	Wins Score	
1	HOBBY, Olivia	SA		0	1	1 0	
2	RAMETTA, Ryley	VIC	1		1	2 0	
3	TUCIC, Andjelina	NSW	0	0		0 0	

1	HOBBY, Olivia	SA	1	RAMETTA, Ryley	VIC
2	RAMETTA, Ryley	VIC		00 s1 / 10 s1	3:07

1	HOBBY, Olivia	SA	2	HOBBY, Olivia	SA
3	TUCIC, Andjelina	NSW		10 s1 / 00	1:48

2	RAMETTA, Ryley	VIC	3	RAMETTA, Ryley	VIC
3	TUCIC, Andjelina	NSW		10 / 00	0:12

Final Results

- RAMETTA, Ryley VIC
- HOBBY, Olivia SA
-

2022 Junior Men and Women Australian National Championships

Gold Coast (AUS), 12 Jun 2022

-66 kg

21 Judoka

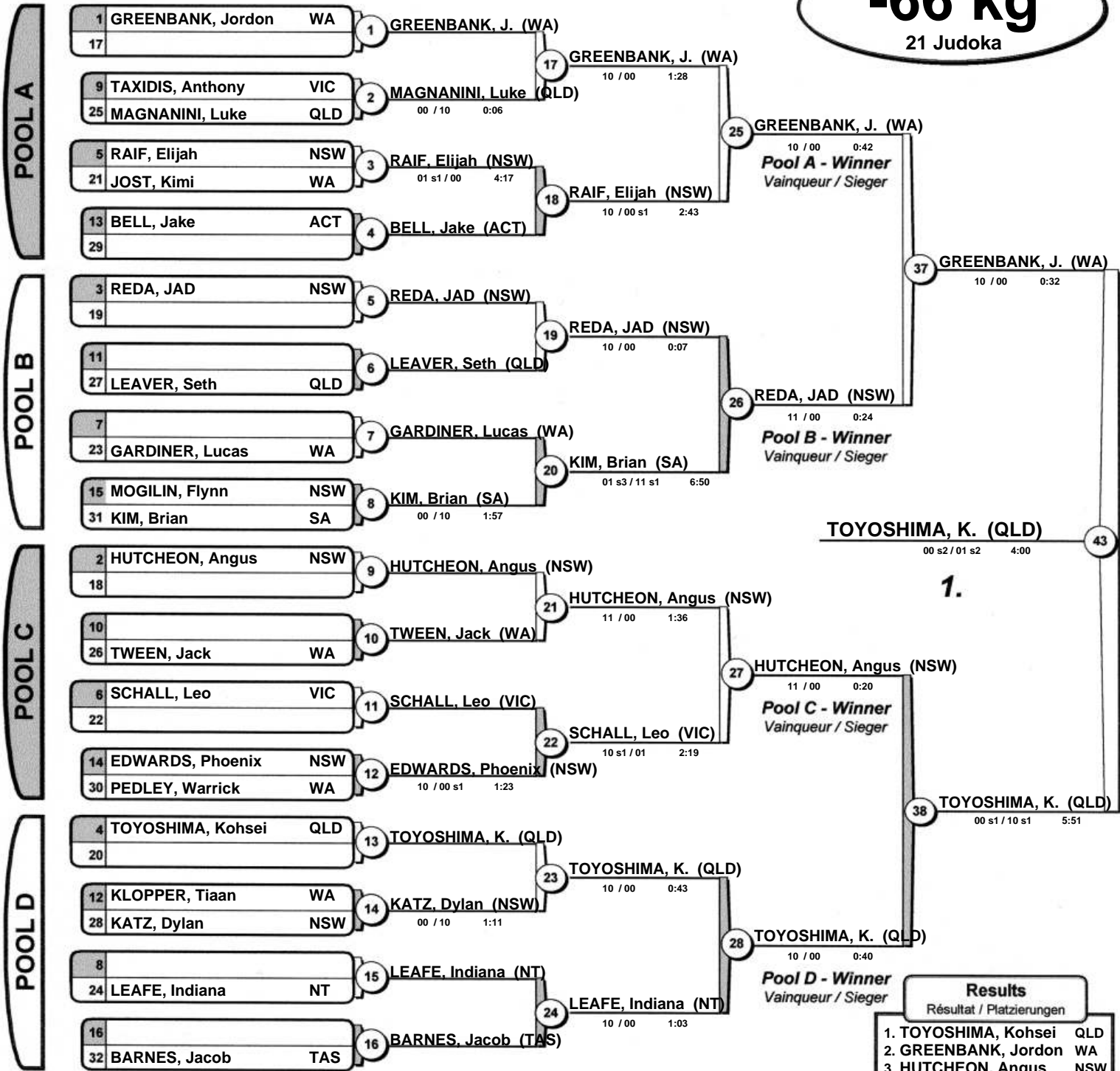

TOYOSHIMA, K. (QLD) [00 s2 / 01 s2 4:00] 43

1.

Results		
Résultat / Platzierungen		
1.	TOYOSHIMA, Kohsei	QLD
2.	GREENBANK, Jordon	WA
3.	HUTCHEON, Angus	NSW
3.	REDA, JAD	NSW
5.	RAIF, Elijah	NSW
5.	KATZ, Dylan	NSW
7.	LEAVER, Seth	QLD
7.	TWEEN, Jack	WA

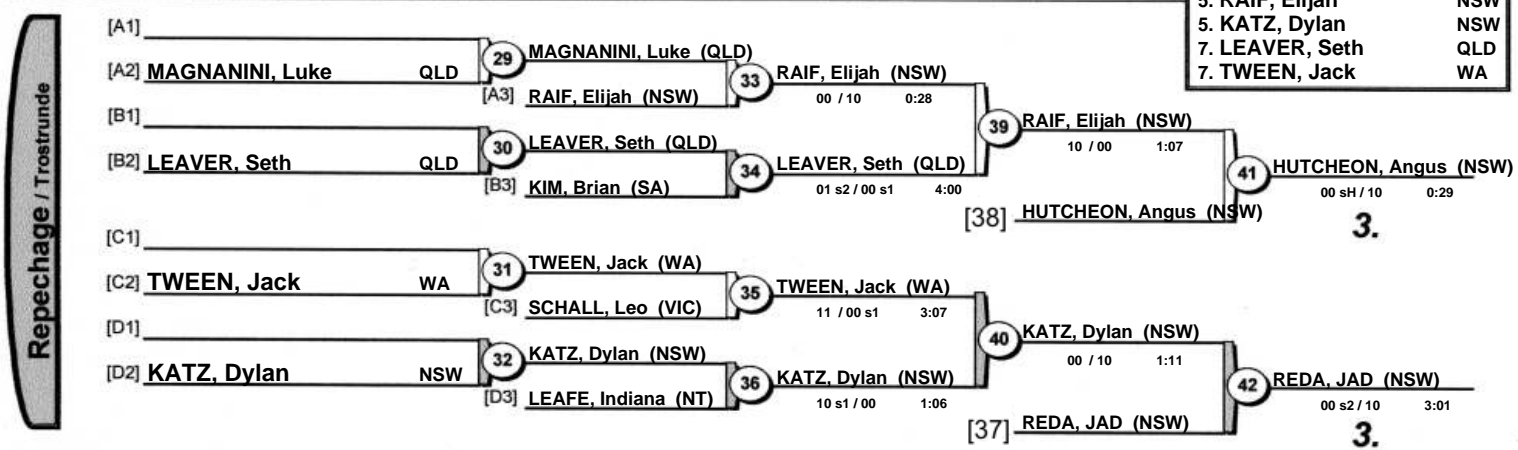

2022 Junior Men and Women Australian National Championships

Gold Coast (AUS), 12 Jun 2022

-70 kg

5 Judoka

			1	3	5	Wins Score	
1	JOYCE, Alannah	NT		1	1	2 0	
3	LEE, Cia	NSW	0		1	1 0	
5	CHARLES, Ashlee	QLD	0	0		0 0	

			2	4	Wins	Scores
2	ANSKEY, Avalon	VIC		1		(0)
4	RITCHIE, Abbie	QLD	0			(0)

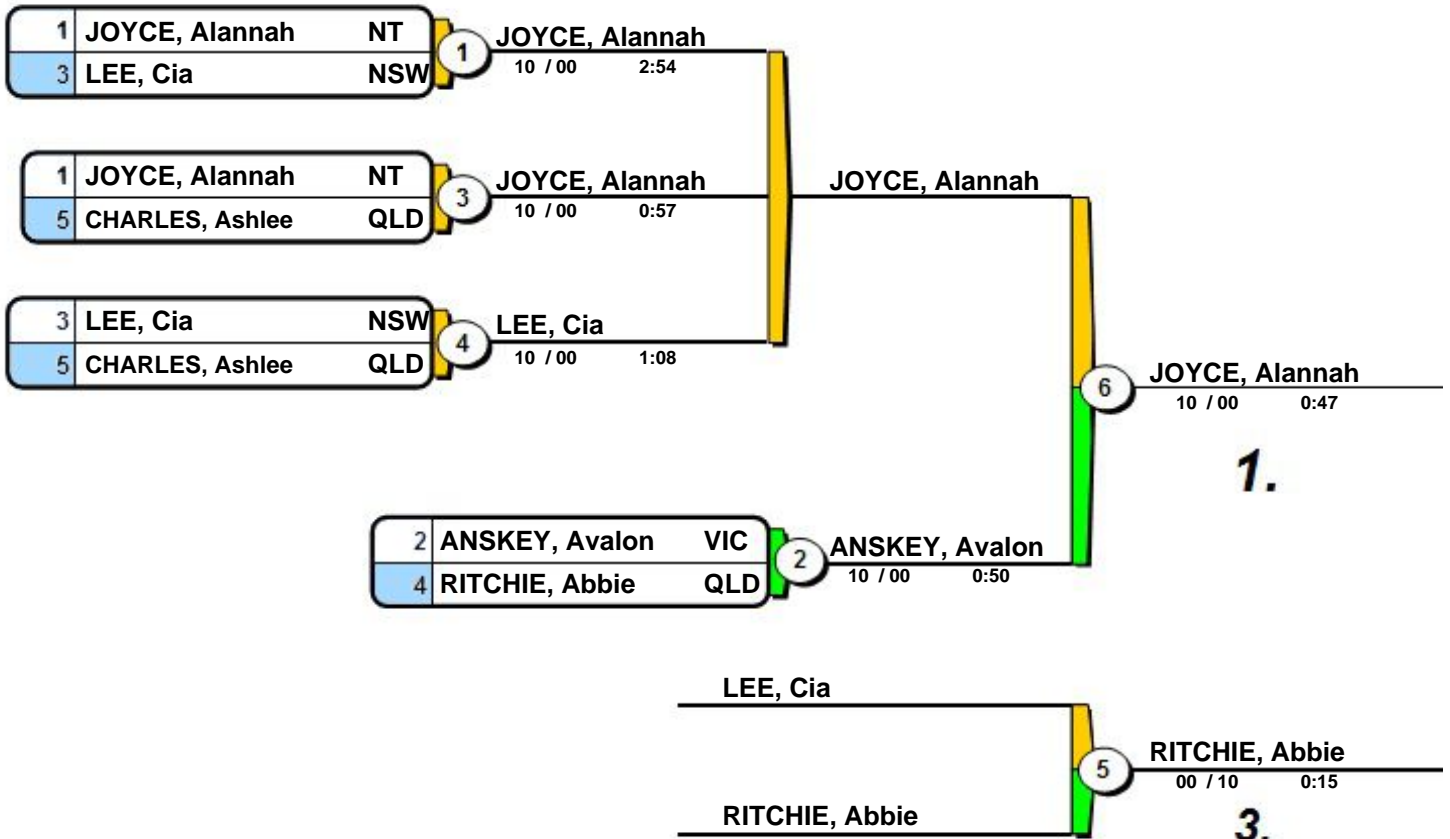

Final Results

- | | |
|-------------------|-----|
| 1. JOYCE, Alannah | NT |
| 2. ANSKEY, Avalon | VIC |
| 3. RITCHIE, Abbie | QLD |

2022 Junior Men and Women Australian National Championships

Gold Coast (AUS), 12 Jun 2022

-73 kg

16 Judoka

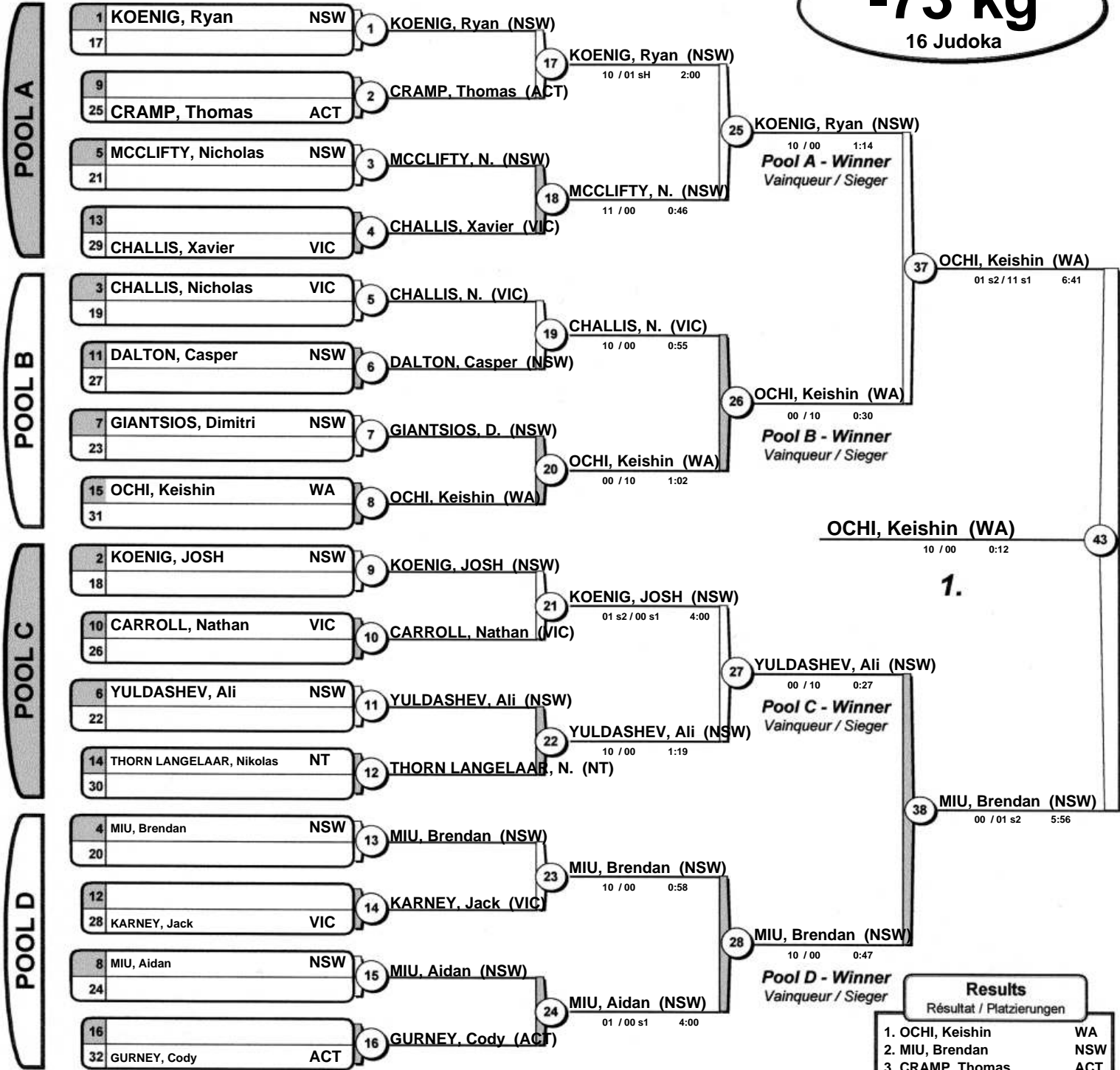

OCHI, Keishin (WA) 10 / 00 0:12

1.

Results	
Résultat / Platzierungen	
1.	OCHI, Keishin WA
2.	MIU, Brendan NSW
3.	CRAMP, Thomas ACT
4.	KOENIG, Ryan NSW
5.	YULDASHEV, Ali NSW
6.	KOENIG, JOSH NSW
7.	GIANTSIOS, Dimitri NSW
8.	KARNEY, Jack VIC

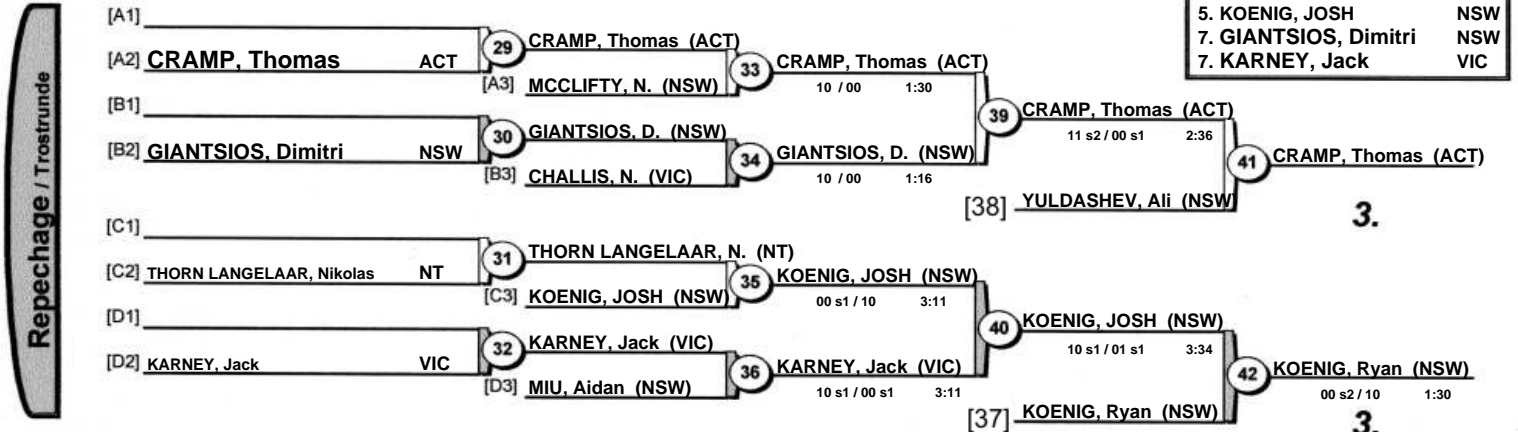

3.

3.

+78 kg

2 Judoka

BEST OF THREE

1	YANG, Shaoxuan	NSW	1	SAZDOV, Mia	VIC	00 / 10	0:17
2	SAZDOV, Mia	VIC					

1	YANG, Shaoxuan	NSW	2	SAZDOV, Mia	VIC	00 s1 / 10	0:43
2	SAZDOV, Mia	VIC					

1	YANG, Shaoxuan	NSW	3	SAZDOV, Mia	VIC		
2	SAZDOV, Mia	VIC					

Final Results

- 1.
- 2.

2022 Junior Men and Women Australian National Championships

Gold Coast (AUS), 12 Jun 2022

-81 kg

8 Judoka

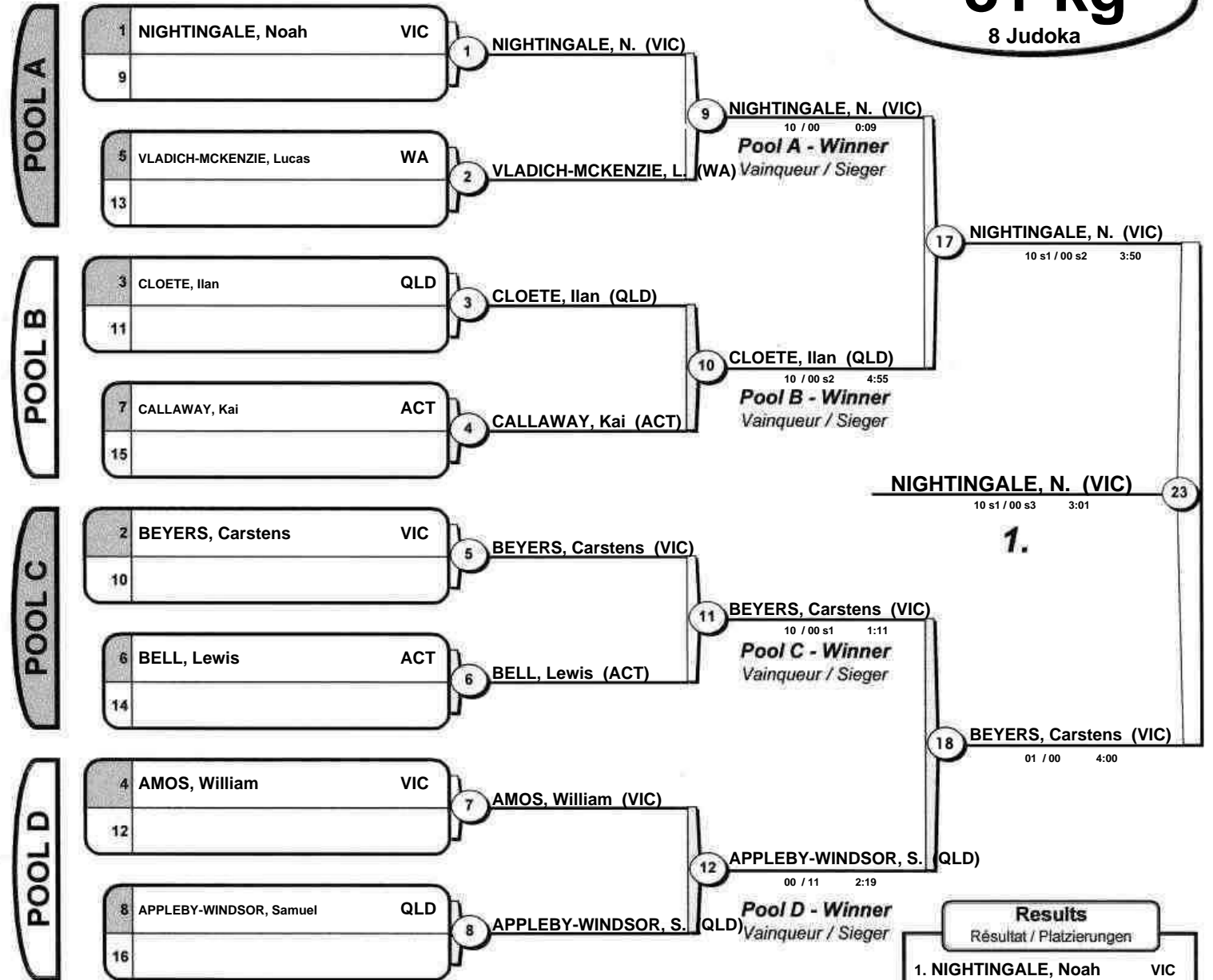

Results	
Résultat / Platzierungen	
1. NIGHTINGALE, Noah	VIC
2. BEYERS, Carstens	VIC
3. APPLEBY-WINDSOR, Samuel	QLD
3. AMOS, William	VIC
5. CALLAWAY, Kai	ACT
5. CLOETE, Ilan	QLD
7. VLADICH-MCKENZIE, Lucas	WA
7. BELL, Lewis	ACT

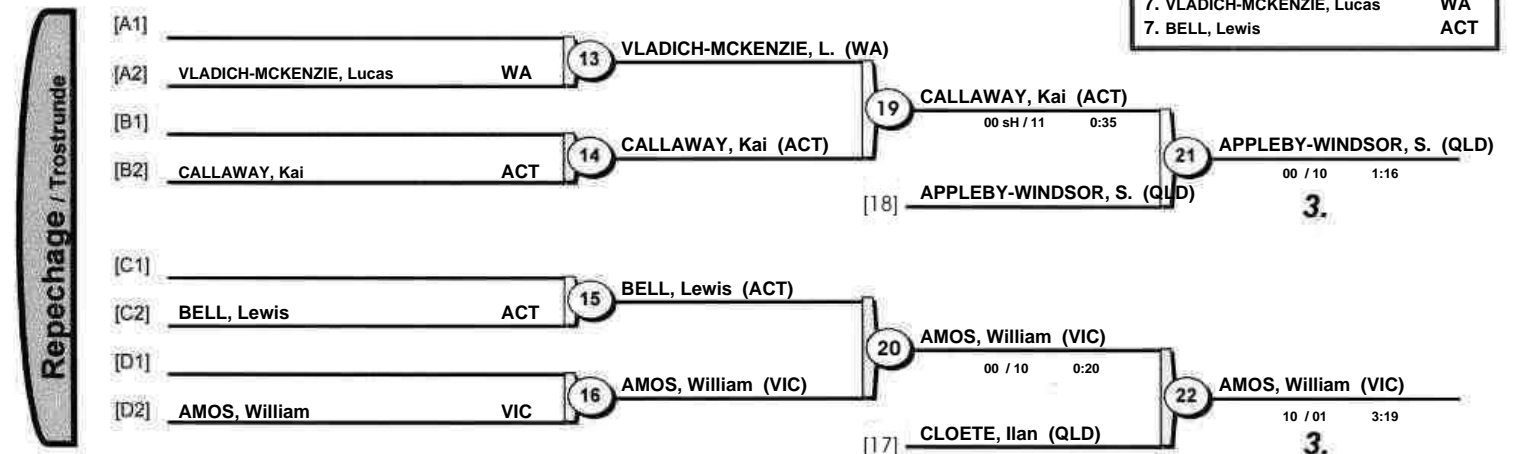

2022 Junior Men and Women Australian National Championships

Gold Coast (AUS), 12 Jun 2022

-90 kg

5 Judoka

			1	3	5	Wins Score	
1	TOMLIN, Lincoln	QLD		0	1	1 0	
3	RICHTER, Kris	WA	1		1	2 0	
5	LANDMAN, Matthew	NSW	0	0		0 0	

			2	4	Wins	Scores
2	VOJNIKOVICH, Danny	VIC		1		(0)
4	SHIPTON, Joshua	WA	0			(0)

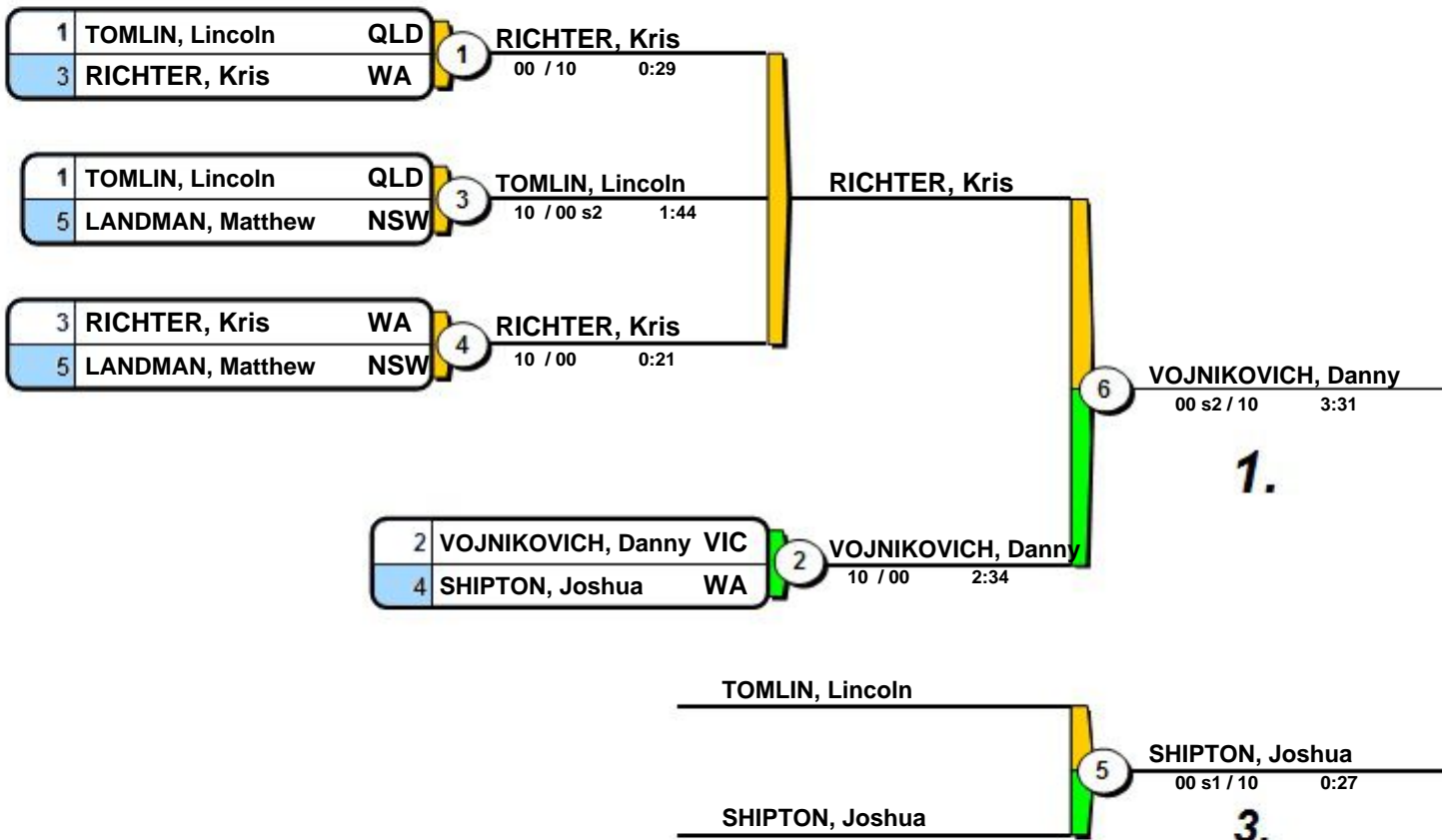

Final Results

1. VOJNIKOVICH, Danny VIC
2. RICHTER, Kris WA
3. SHIPTON, Joshua WA

2022 Junior Men and Women Australian National Championships

Gold Coast (AUS), 12 Jun 2022

-100 kg

4 Judoka

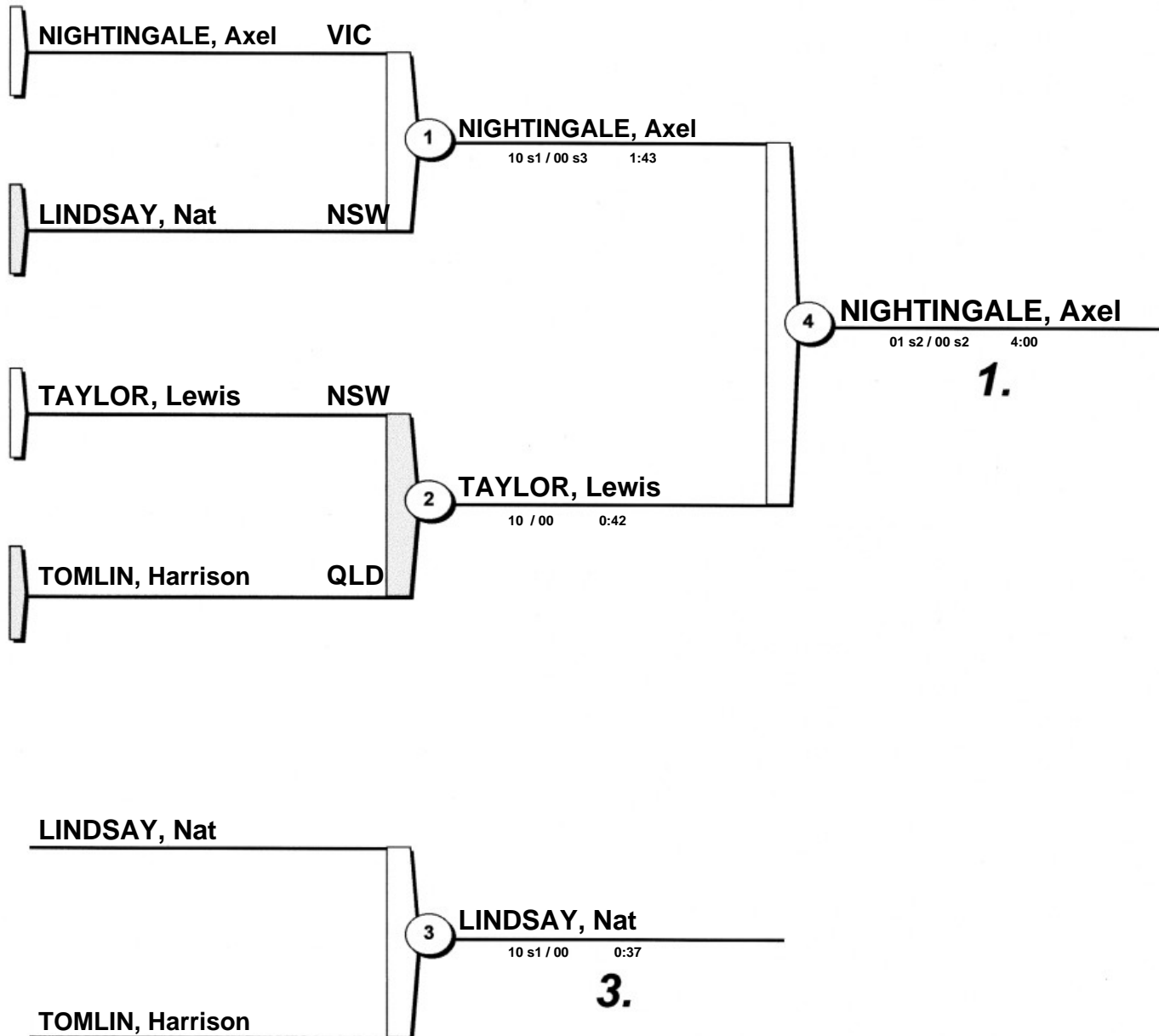

Final Results

- | | |
|----------------------|-----|
| 1. NIGHTINGALE, Axel | VIC |
| 2. TAYLOR, Lewis | NSW |
| 3. LINDSAY, Nat | NSW |

2022 Junior Men and Women Australian National Championships

Gold Coast (AUS), 12 Jun 2022

+100 kg

6 Judoka

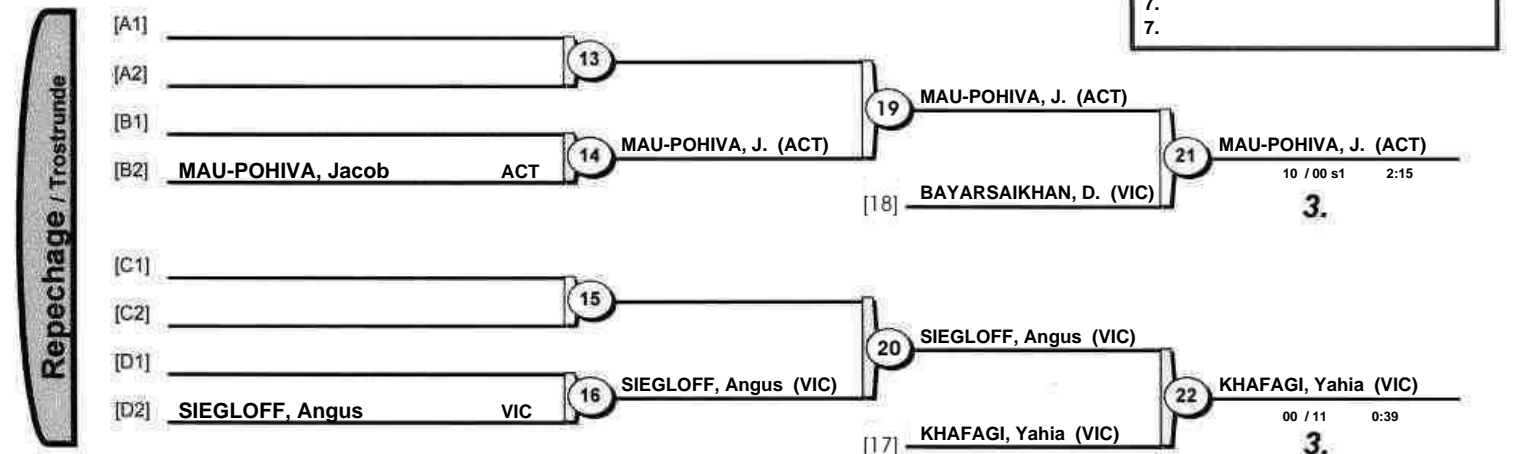
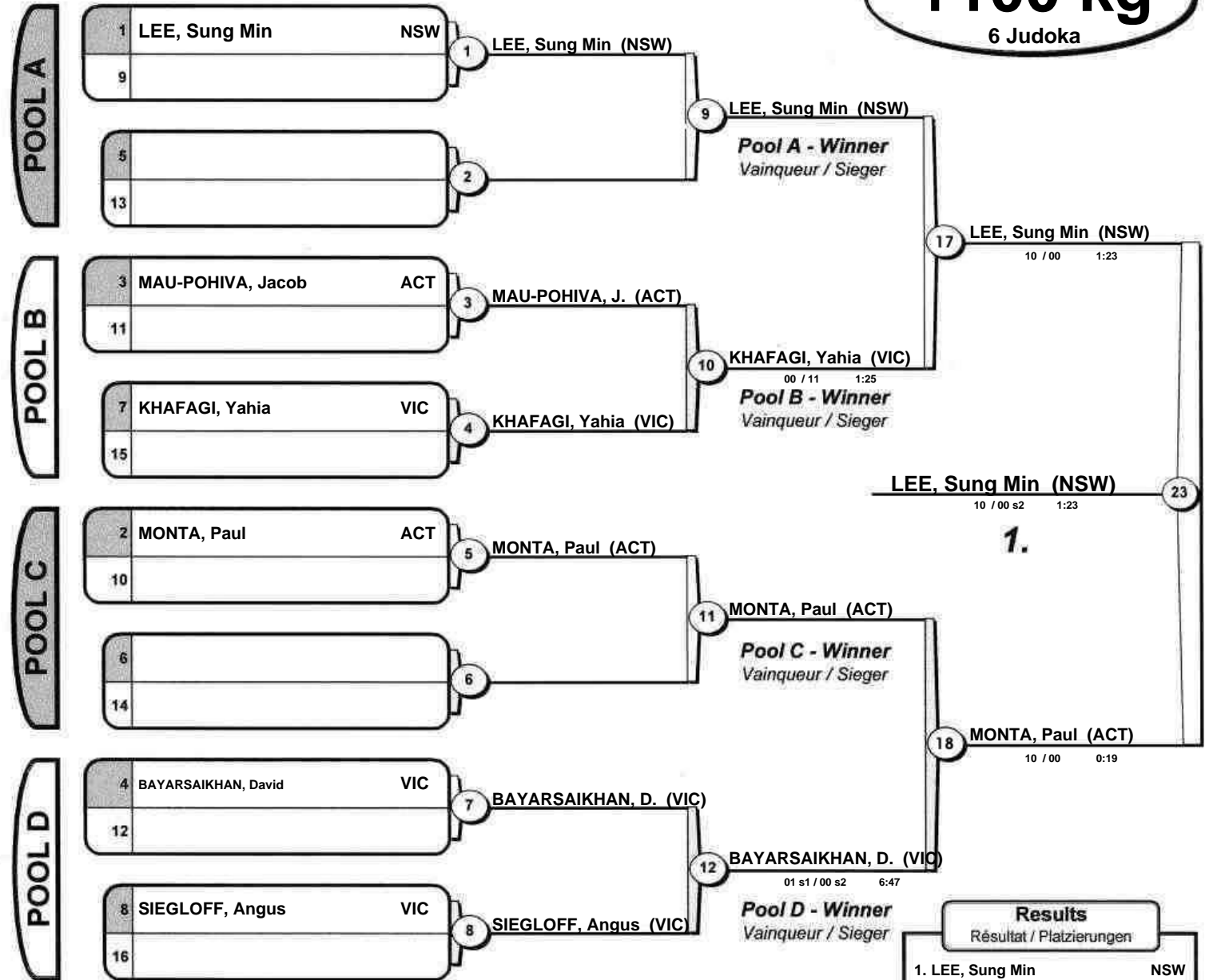

2022 Senior Men and Women Australian National Championships

Gold Coast (AUS), 12 Jun 2022

-48 kg

9 Judoka

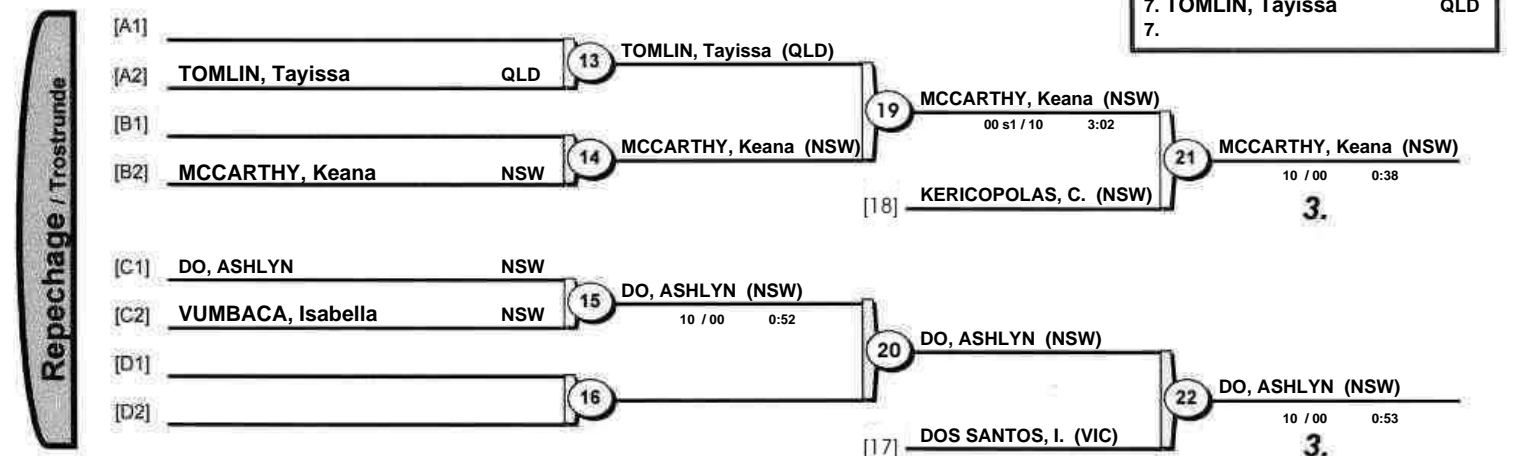
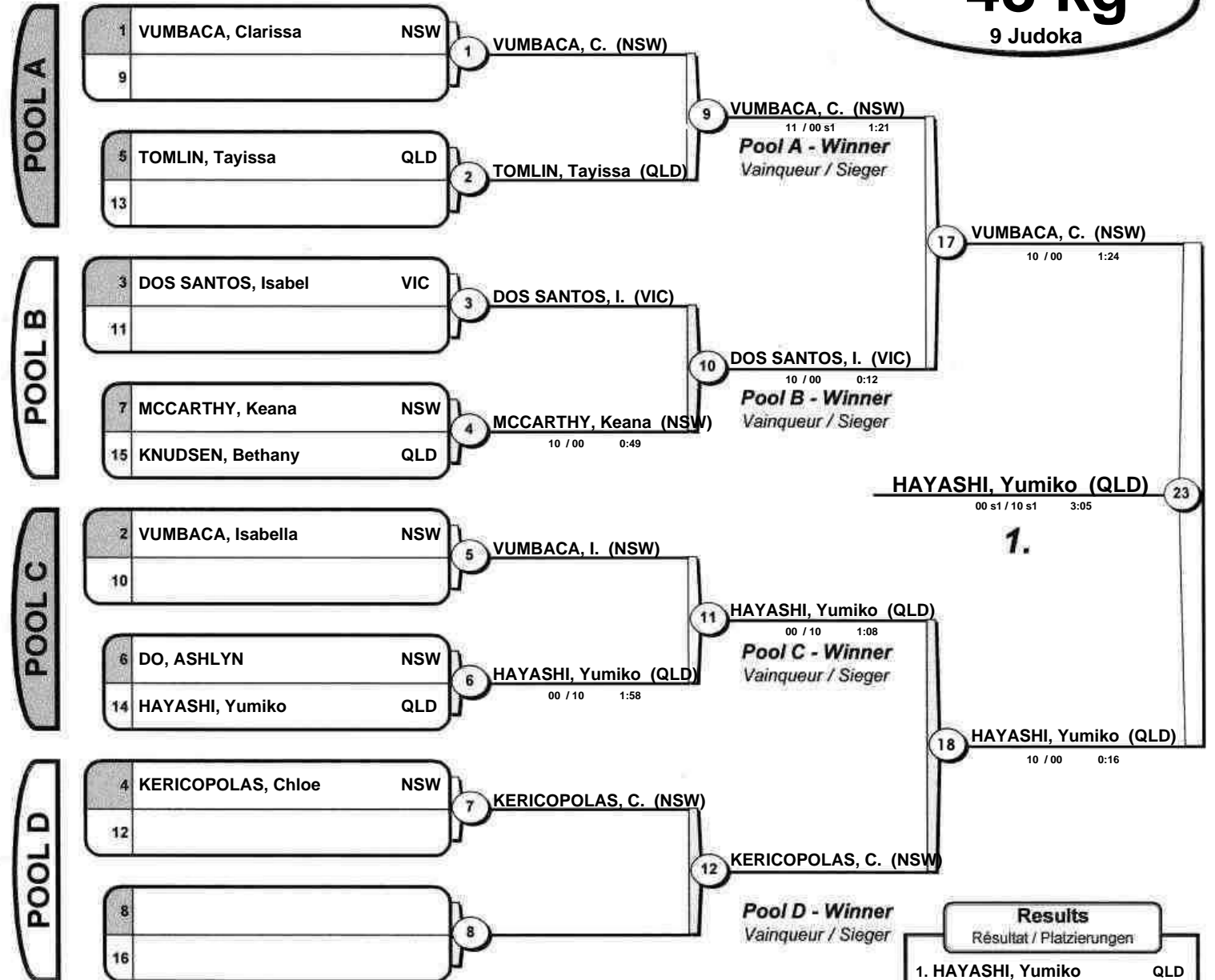

2022 Senior Men and Women Australian National Championships

Gold Coast (AUS), 12 Jun 2022

-52 kg

4 Judoka

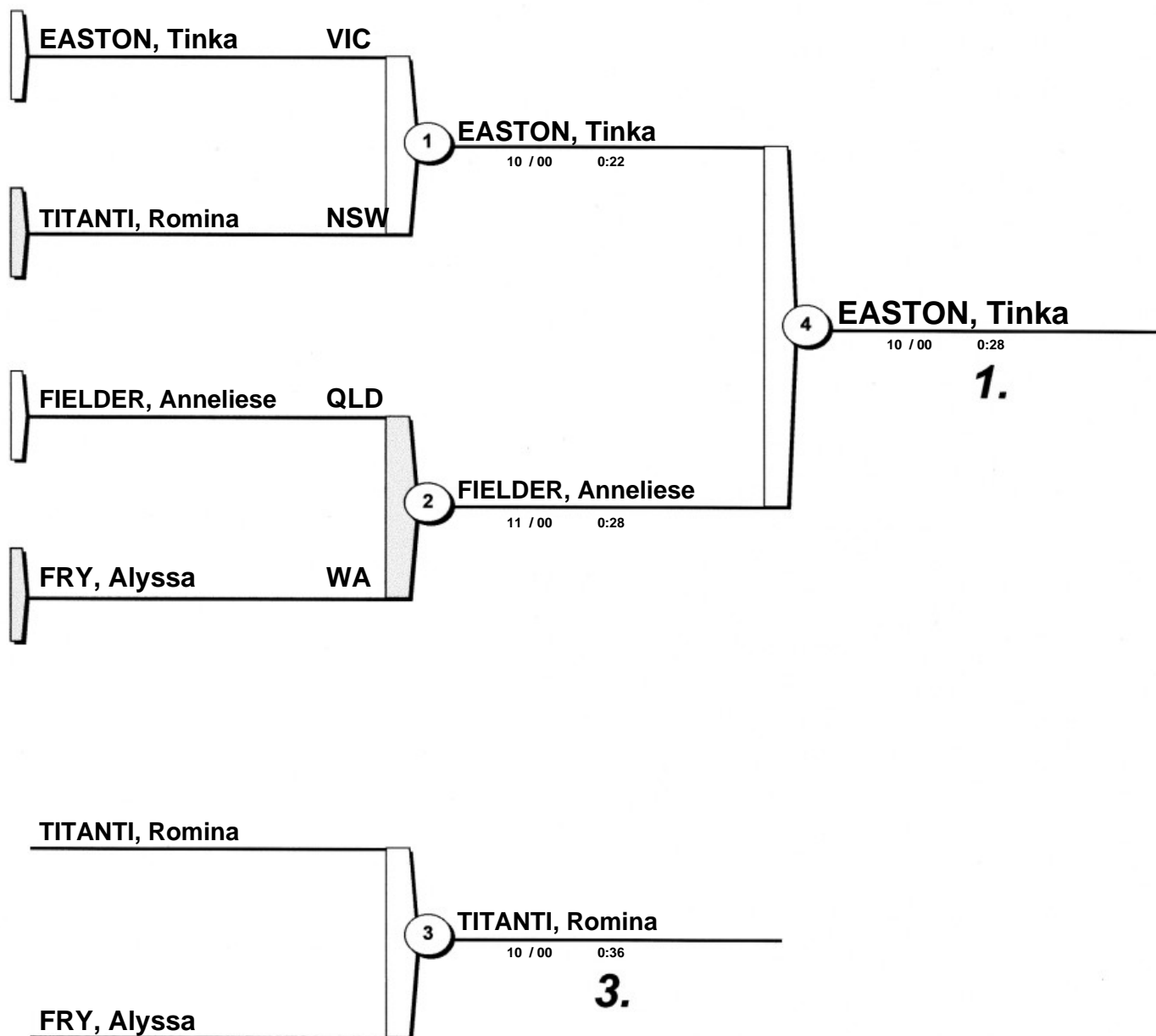

Final Results

- | | |
|-----------------------|-----|
| 1. EASTON, Tinka | VIC |
| 2. FIELDER, Anneliese | QLD |
| 3. TITANTI, Romina | NSW |

2022 Senior Men and Women Australian National Championships

Gold Coast (AUS), 12 Jun 2022

-57 kg

8 Judoka

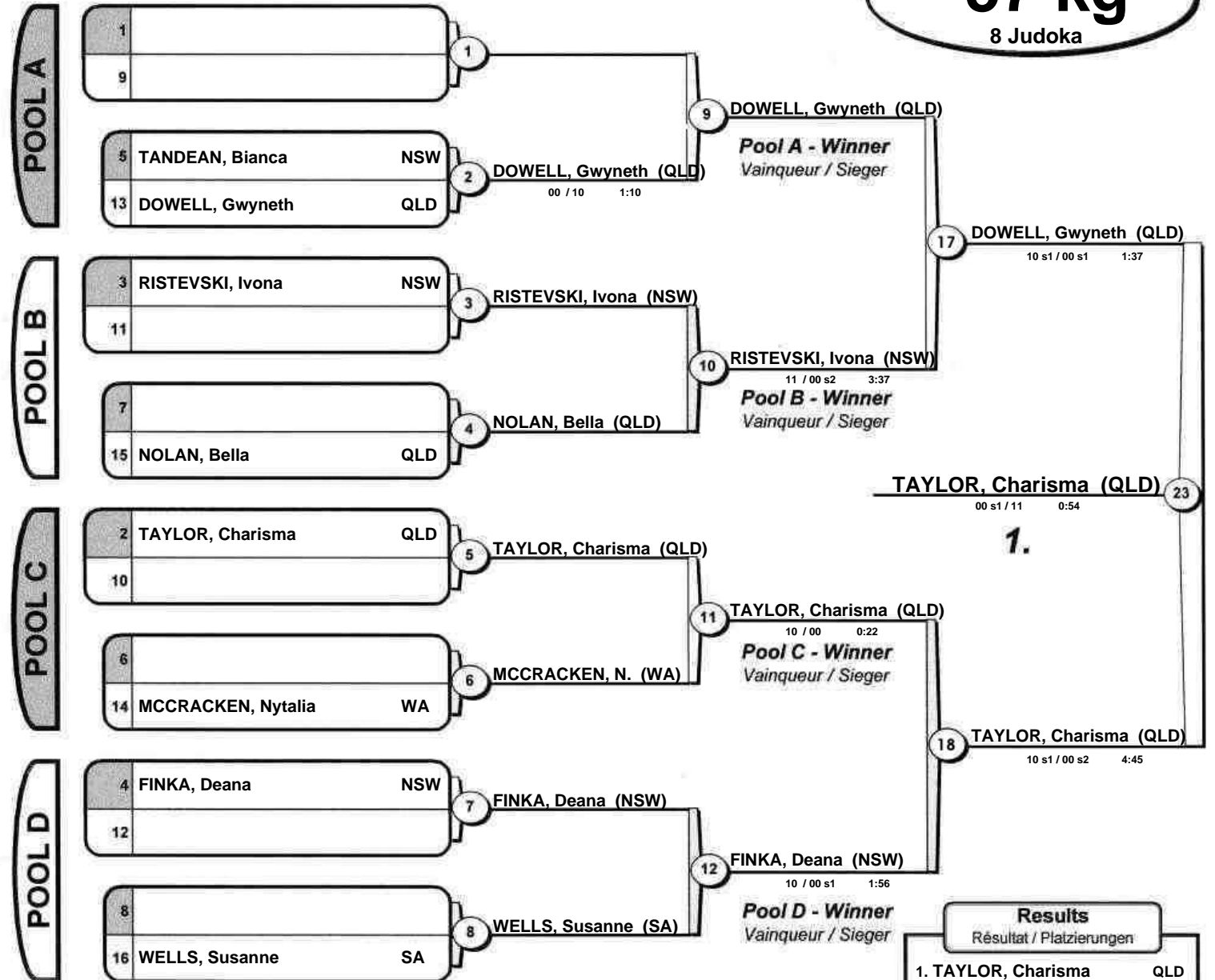

Results	
Résultat / Platzierungen	
1. TAYLOR, Charisma	QLD
2. DOWELL, Gwyneth	QLD
3. FINKA, Deana	NSW
3. RISTEVSKI, Ivona	NSW
5. TANDEAN, Bianca	NSW
5. MCCRACKEN, Nyotalia	WA
7. NOLAN, Bella	QLD
7. WELLS, Susanne	SA

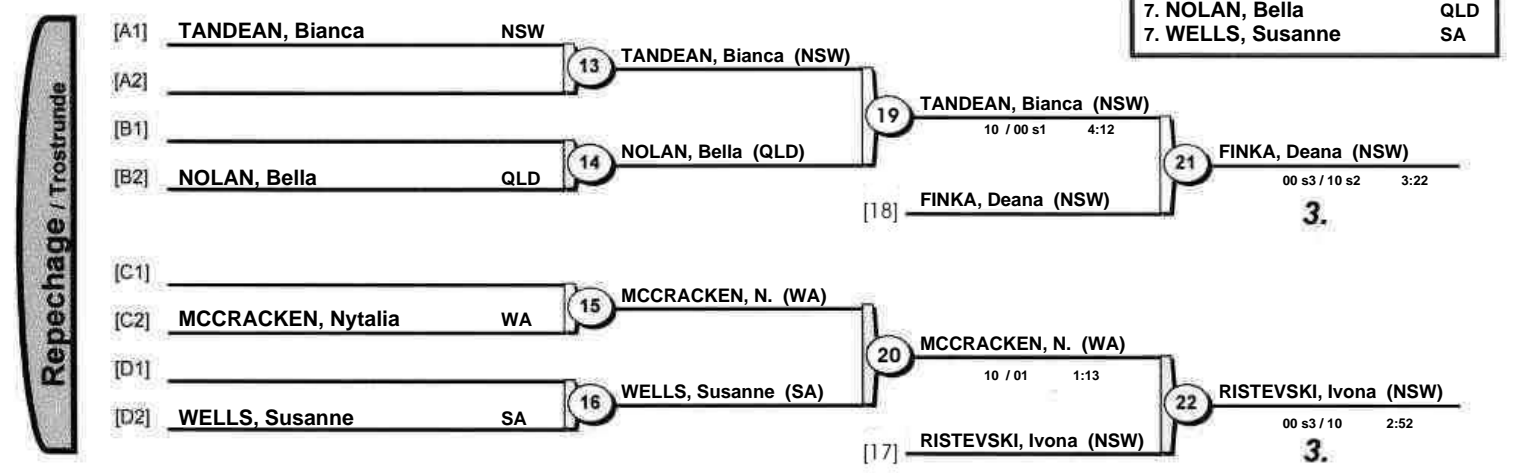

2022 Senior Men and Women Australian National Championships

Gold Coast (AUS), 12 Jun 2022

-63 kg

6 Judoka

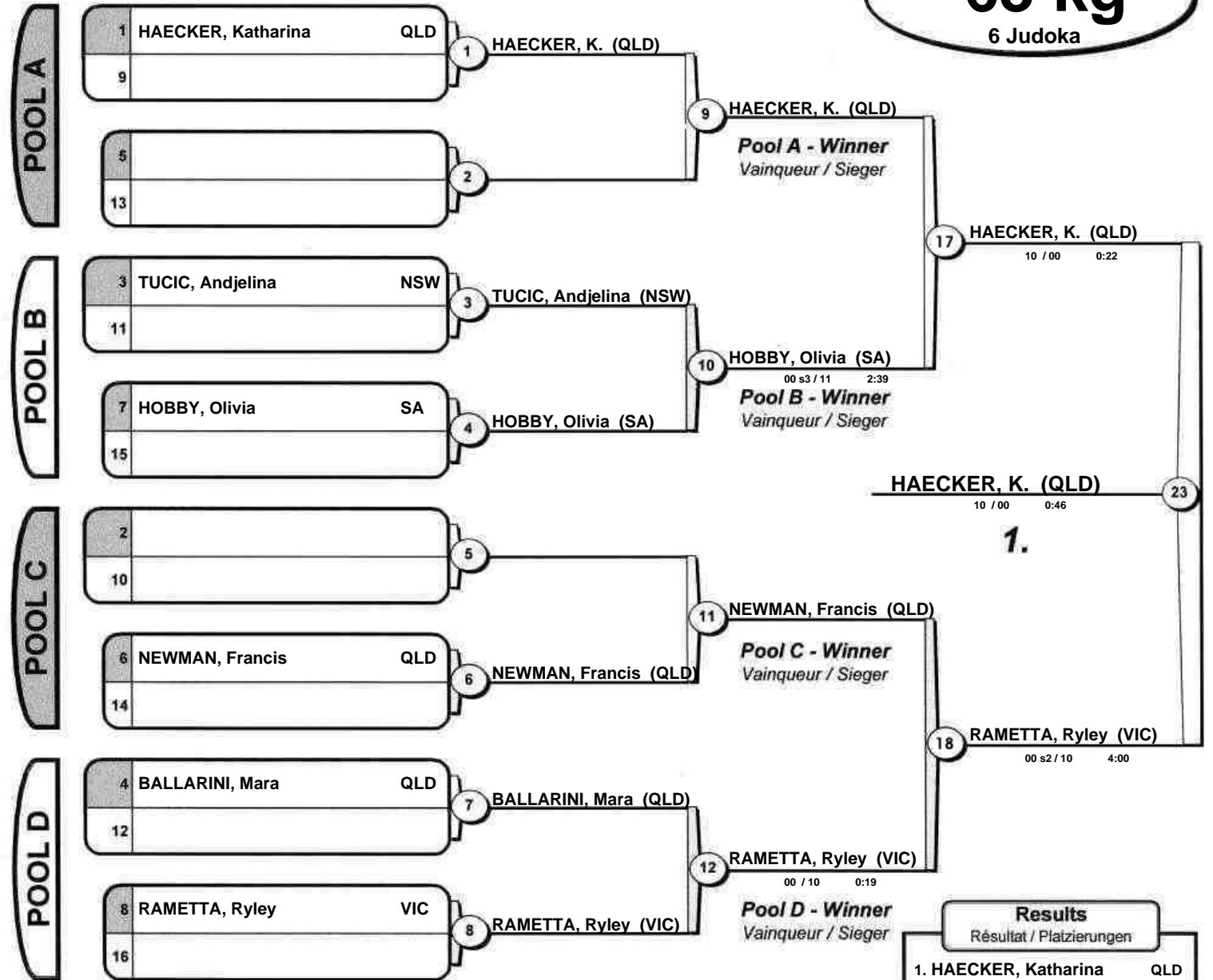

Results		
Résultat / Platzierungen		
1.	HAECKER, Katharina	QLD
2.	RAMEY, Ryley	VIC
3.	NEWMAN, Francis	QLD
3.	HOBBY, Olivia	SA
5.	TUCIC, Andjelina	NSW
5.	BALLARINI, Mara	QLD
7.		
7.		

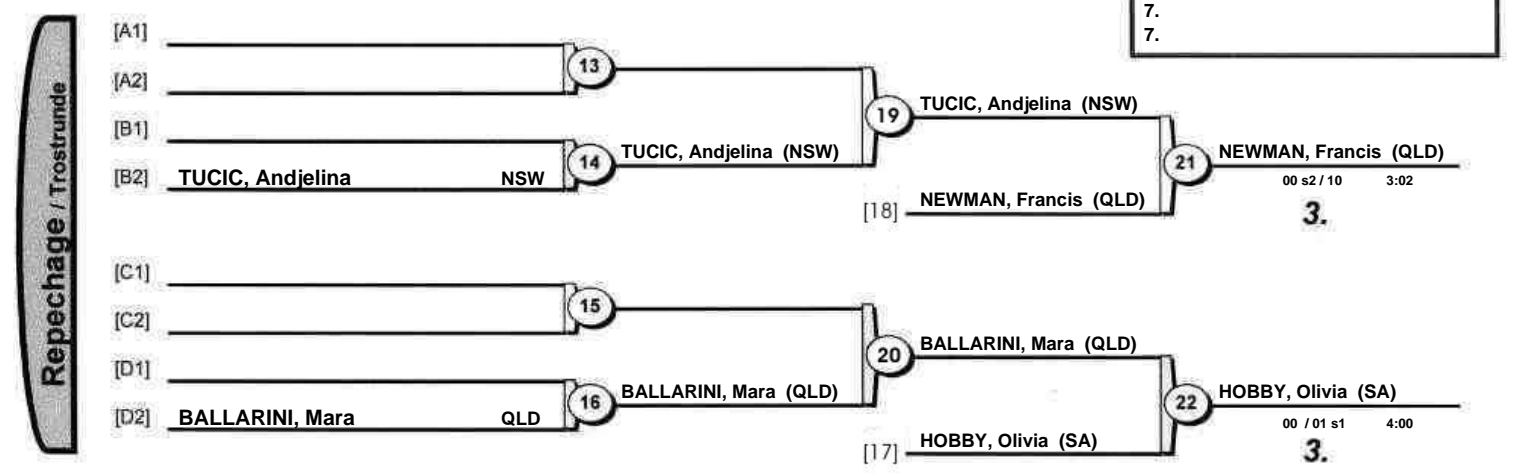

2022 Senior Men and Women Australian National Championships

Gold Coast (AUS), 12 Jun 2022

-70 kg

7 Judoka

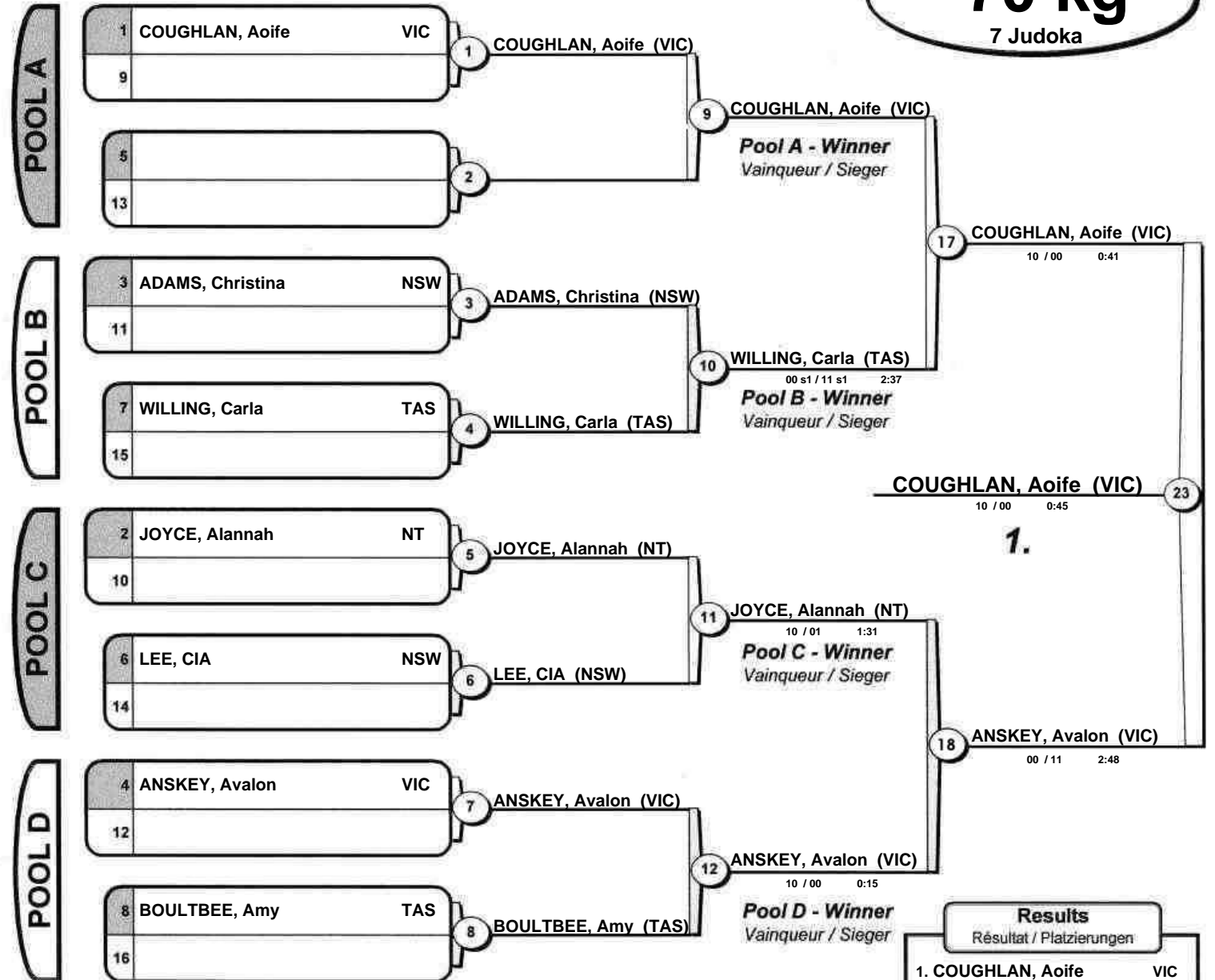

Results	
Résultat / Platzierungen	
1.	COUGHLAN, Aoife (VIC)
2.	ANSKEY, Avalon (VIC)
3.	JOYCE, Alannah (NT)
3.	WILLING, Carla (TAS)
5.	ADAMS, Christina (NSW)
5.	BOULTBEE, Amy (TAS)
7.	LEE, CIA (NSW)

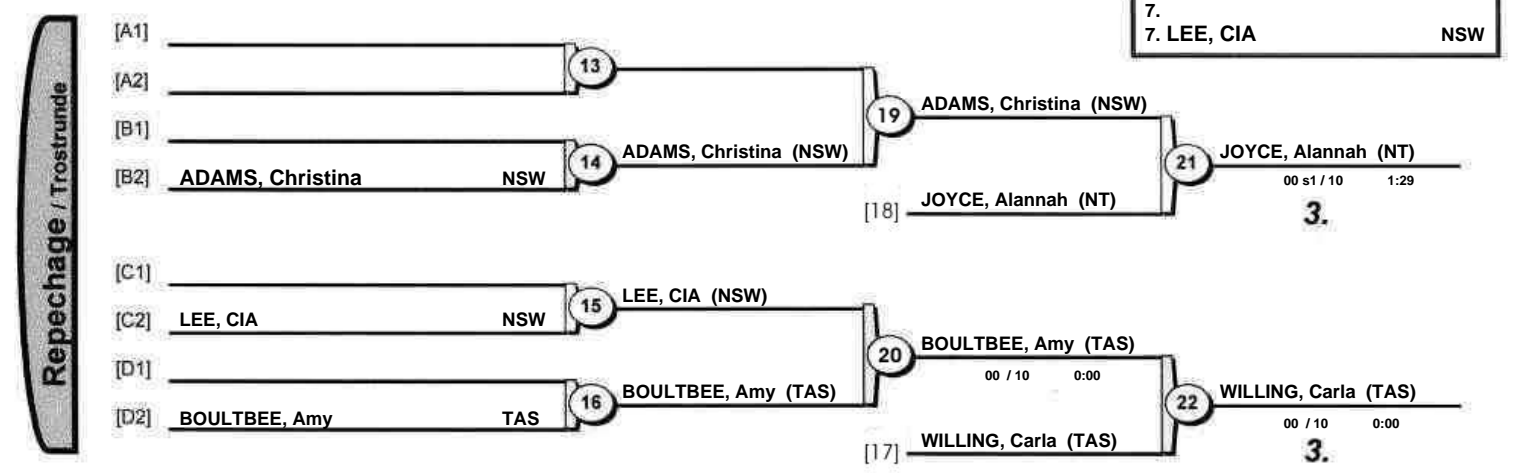

2022 Senior Men and Women Australian National Championships

Gold Coast (AUS), 12 Jun 2022

+78 kg

4 Judoka

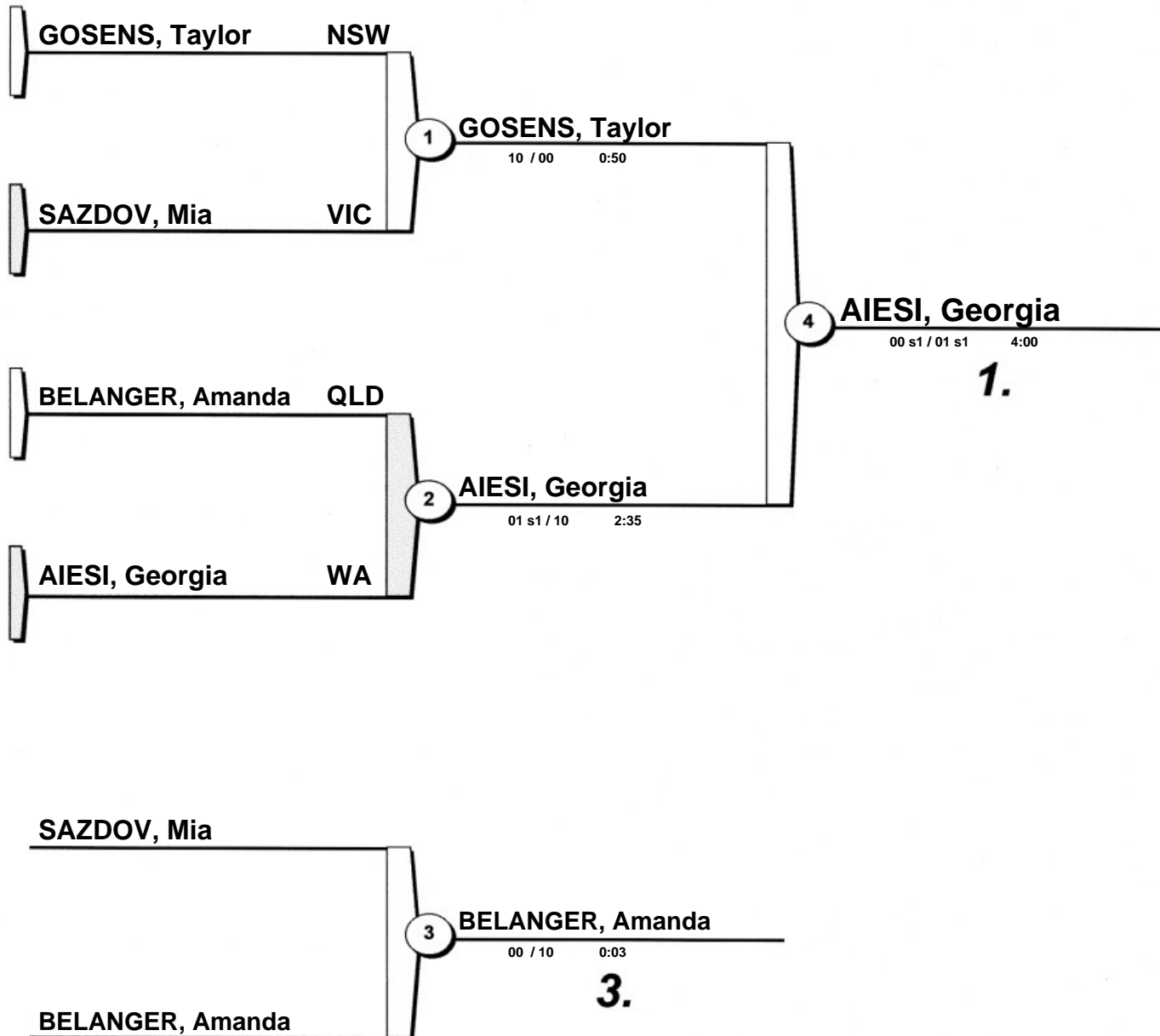

Final Results

1. AIESI, Georgia WA
2. GOSSENS, Taylor NSW
3. BELANGER, Amanda QLD

2022 Senior Men and Women Australian National Championships

Gold Coast (AUS), 12 Jun 2022

-60 kg

11 Judoka

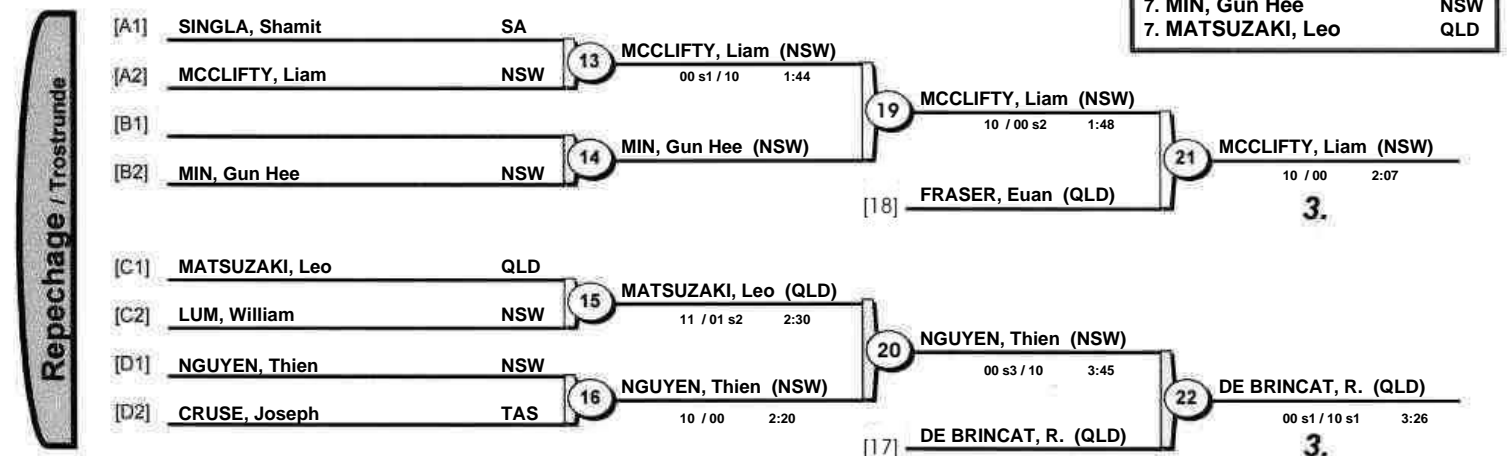
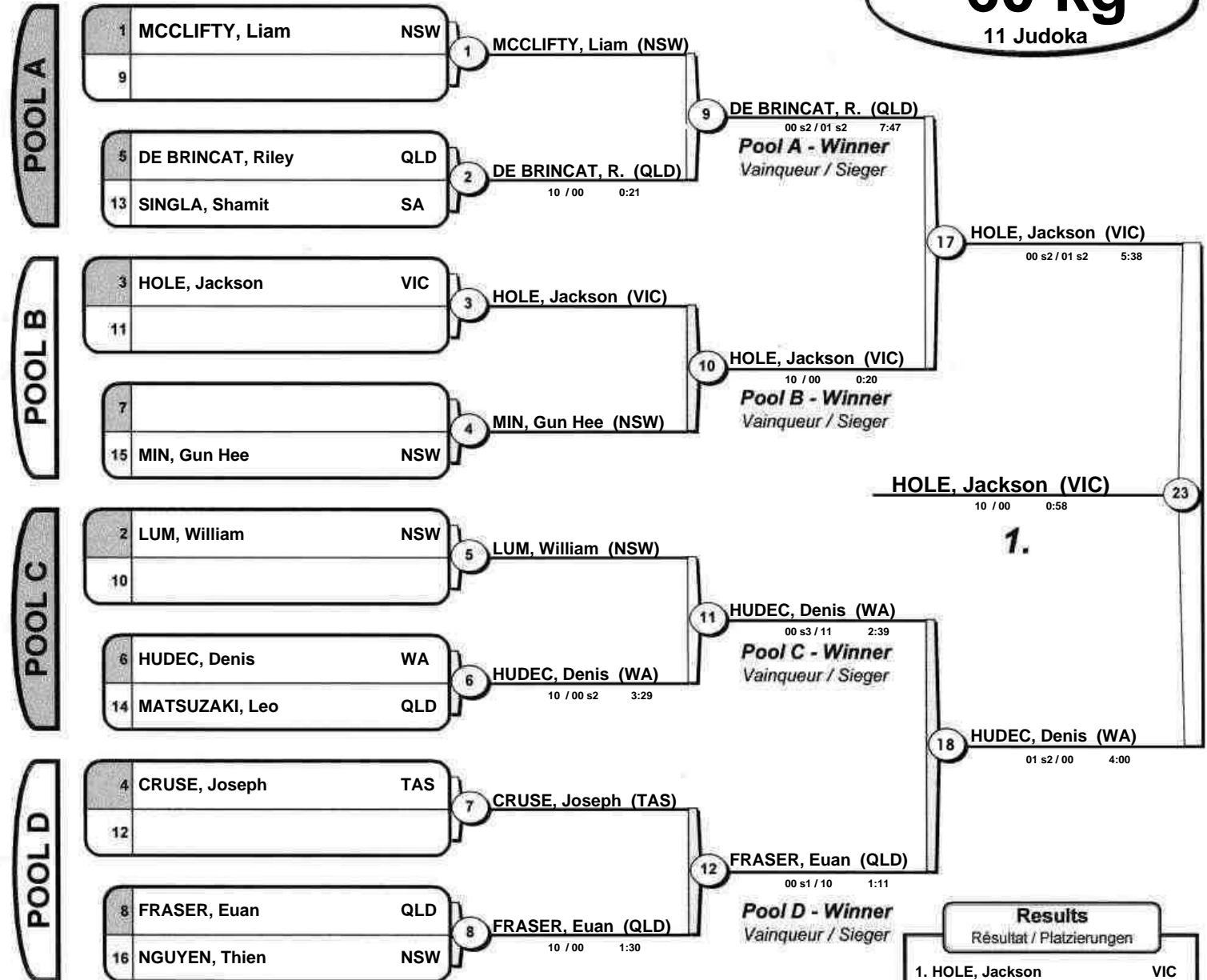

2022 Senior Men and Women Australian National Championships

Gold Coast (AUS), 12 Jun 2022

-66 kg

19 Judoka

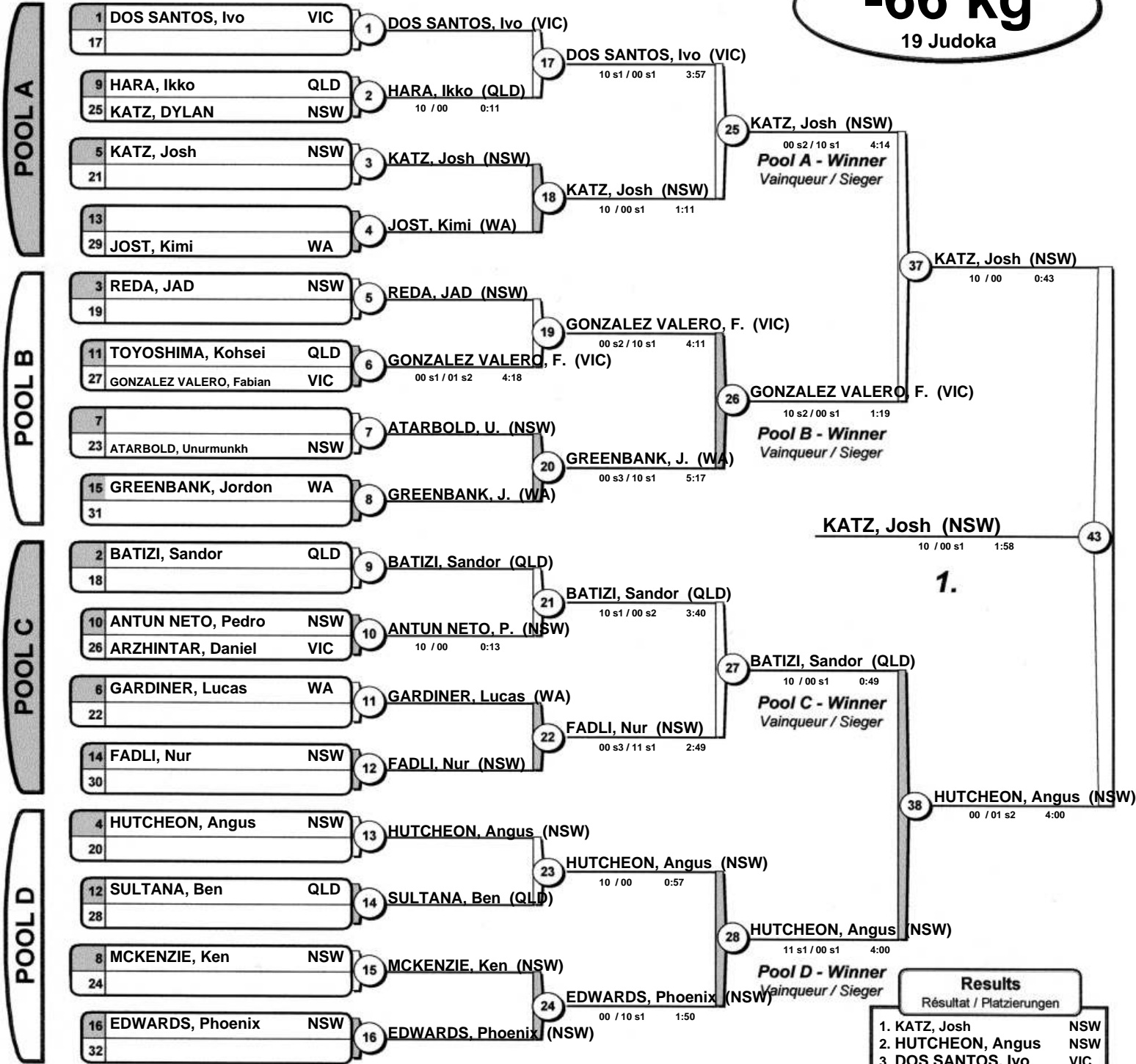

37 KATZ, Josh (NSW)

KATZ, Josh (NSW)

1.

38 HUTCHEON, Angus (NSW)

28 HUTCHEON, Angus (NSW)

24 EDWARDS, Phoenix (NSW)

Results	
Résultat / Platzierungen	
1.	KATZ, Josh NSW
2.	HUTCHEON, Angus NSW
3.	DOS SANTOS, Ivo VIC
4.	GONZALEZ VALERO, Fabian VIC
5.	BATIZI, Sandor QLD
6.	ANTUN NETO, Pedro NSW
7.	GREENBANK, Jordon WA
7.	EDWARDS, Phoenix NSW

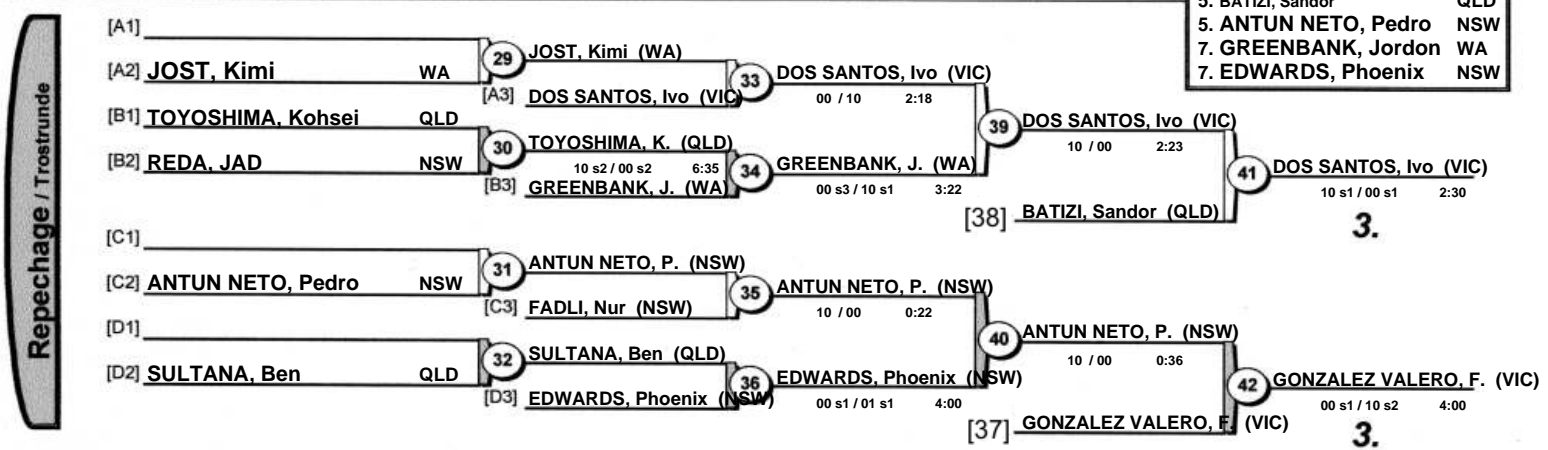

3.

3.

2022 Senior Men and Women Australian National Championships

Gold Coast (AUS), 12 Jun 2022

-73 kg

21 Judoka

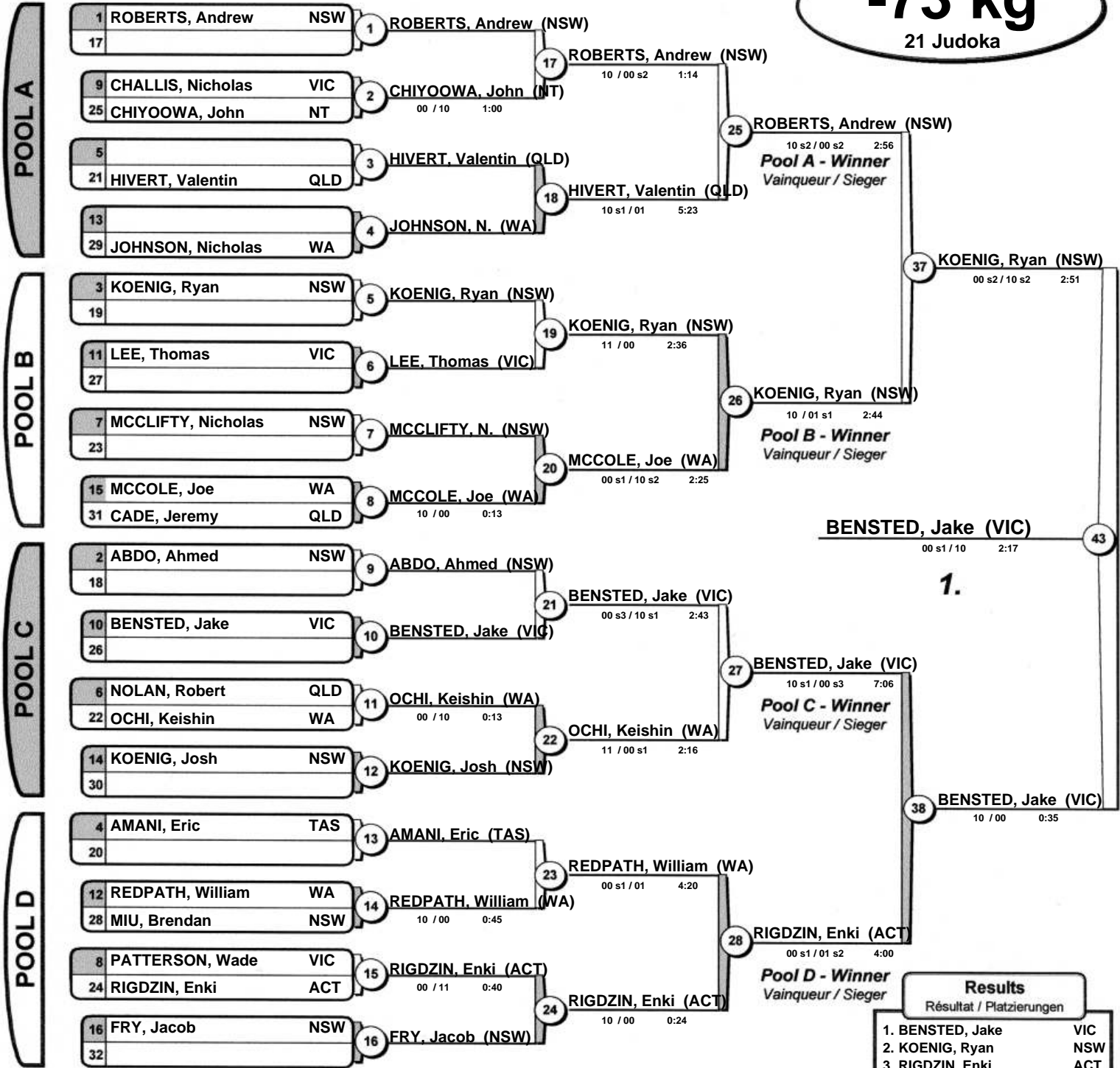

Results	
Résultat / Platzierungen	
1.	BENSTED, Jake VIC
2.	KOENIG, Ryan NSW
3.	RIGDZIN, Enki ACT
4.	OCHI, Keishin WA
5.	MCCOLE, Joe WA
6.	ROBERTS, Andrew NSW
7.	HIVERT, Valentin QLD
7.	REDPATH, William WA

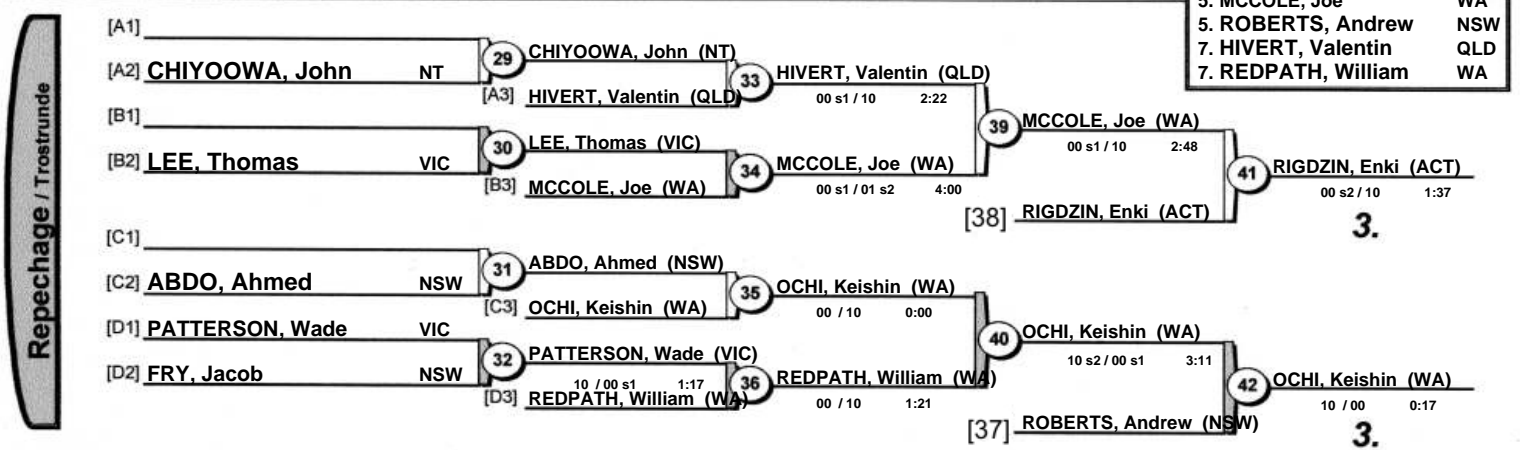

2022 Senior Men and Women Australian National Championships

Gold Coast (AUS), 12 Jun 2022

-81 kg

15 Judoka

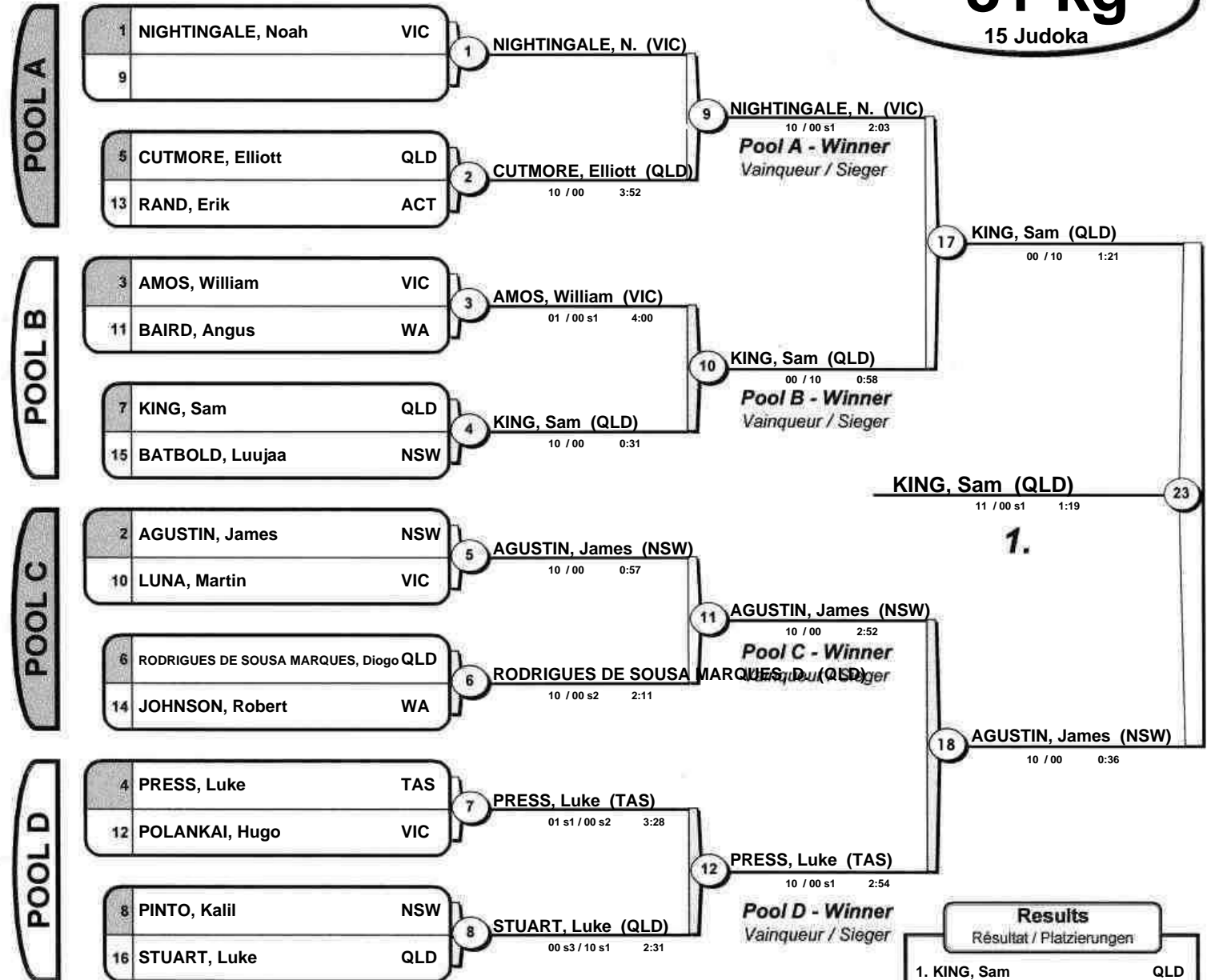

Results	
Résultat / Platzierungen	
1.	KING, Sam QLD
2.	AGUSTIN, James NSW
3.	CUTMORE, Elliott QLD
3.	NIGHTINGALE, Noah VIC
5.	PRESS, Luke TAS
5.	RODRIGUES DE SOUSA MARQUES, Diogo QLD
7.	AMOS, William VIC
7.	STUART, Luke QLD

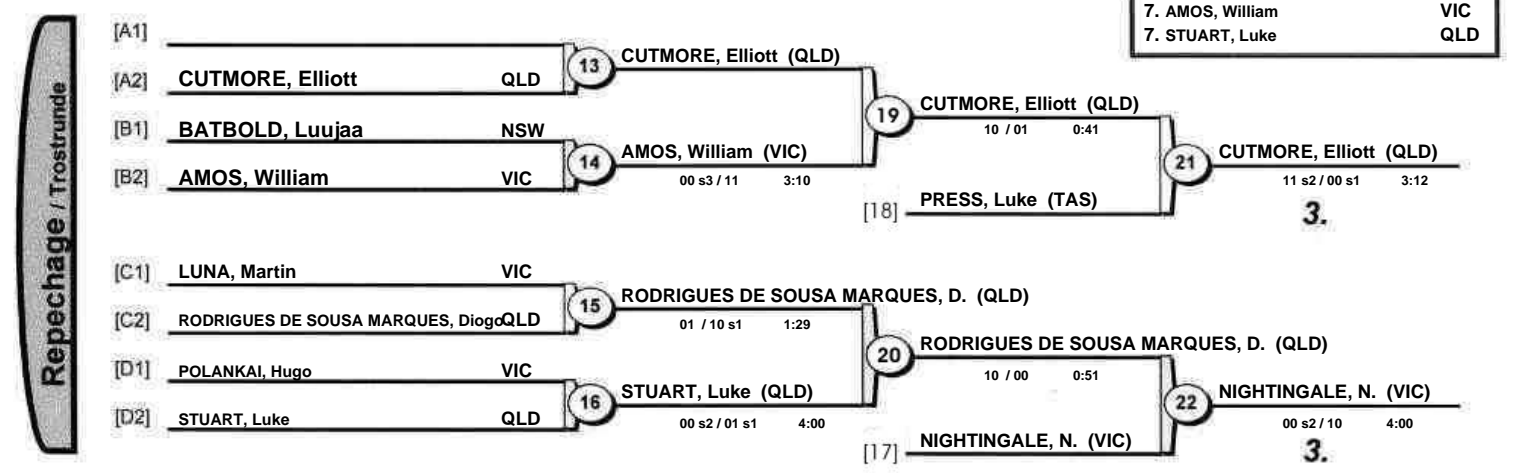

2022 Senior Men and Women Australian National Championships

Gold Coast (AUS), 12 Jun 2022

-90 kg

16 Judoka

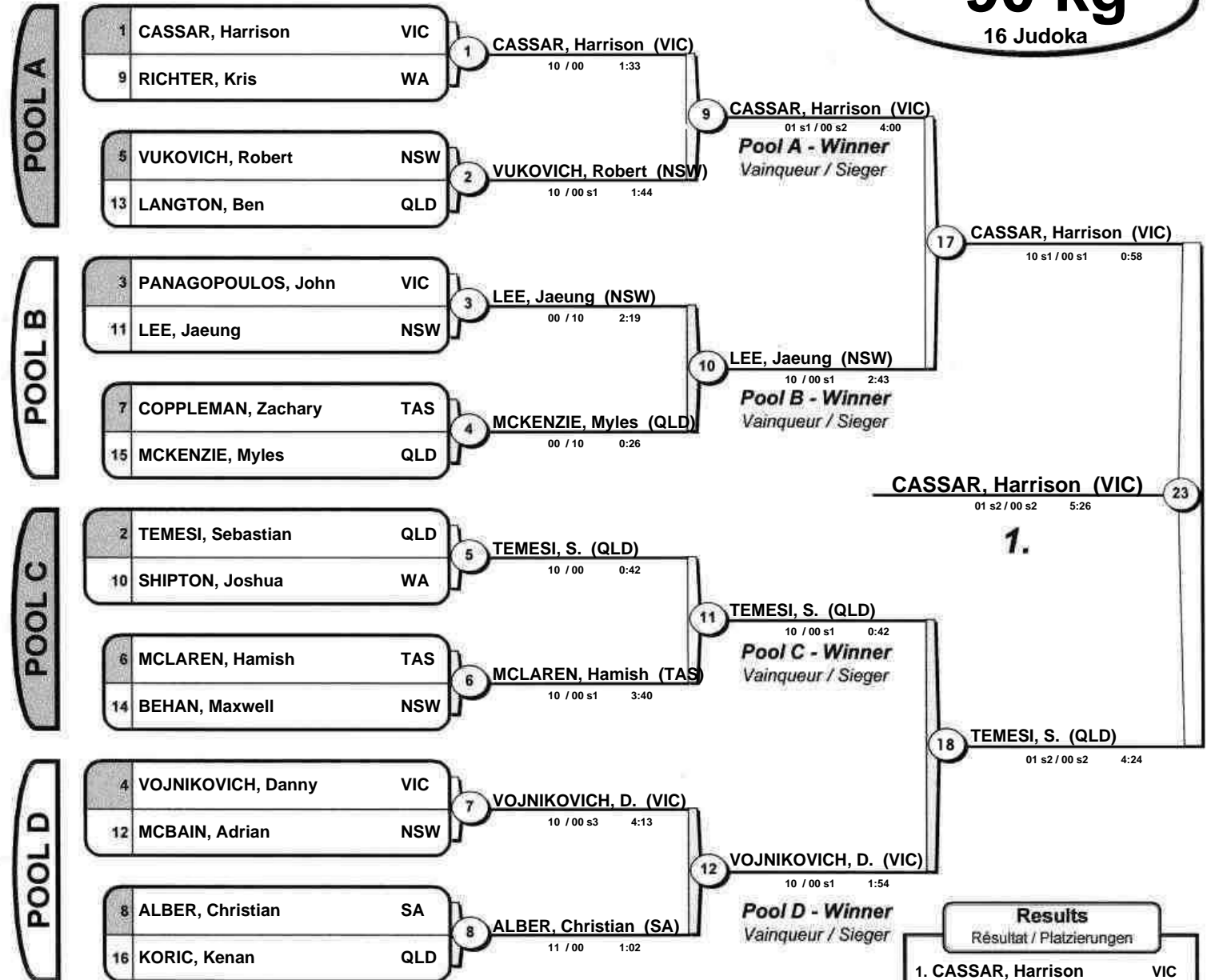

Results	
Résultat / Platzierungen	
1.	CASSAR, Harrison VIC
2.	TEMESI, Sebastian QLD
3.	VOJNIKOVICH, Danny VIC
3.	MCBAIN, Adrian NSW
5.	VUKOVICH, Robert NSW
5.	LEE, Jaeung NSW
7.	MCKENZIE, Myles QLD
7.	SHIPTON, Joshua WA

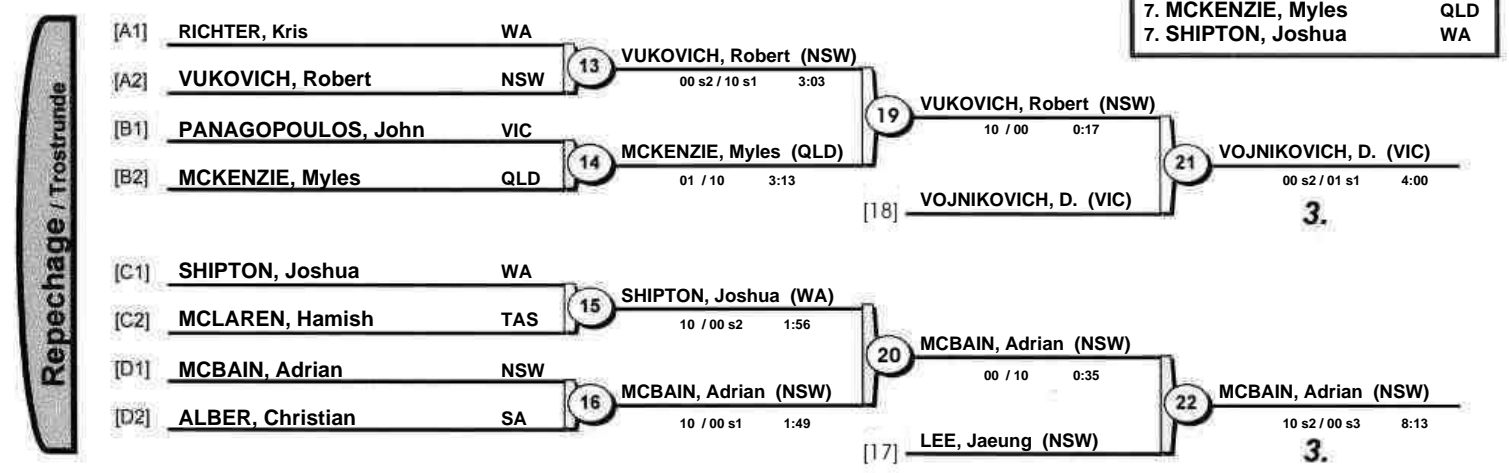

2022 Senior Men and Women Australian National Championships

Gold Coast (AUS), 12 Jun 2022

-100 kg

10 Judoka

POOL A

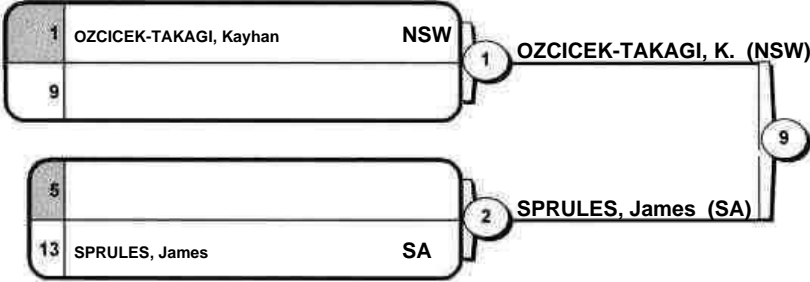

9 OZCICEK-TAKAGI, K. (NSW)
10 / 00 1:23
Pool A - Winner
Vainqueur / Sieger

POOL B

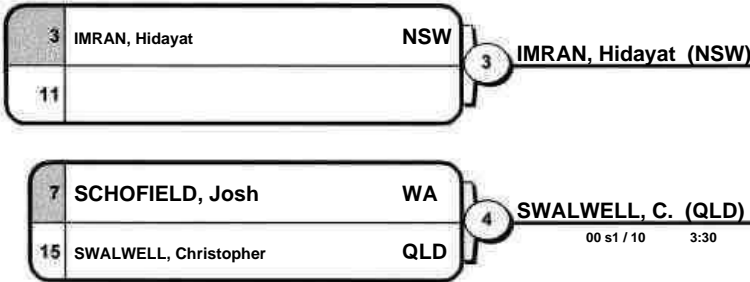

10 SWALWELL, C. (QLD)
00 / 10 0:48
Pool B - Winner
Vainqueur / Sieger

POOL C

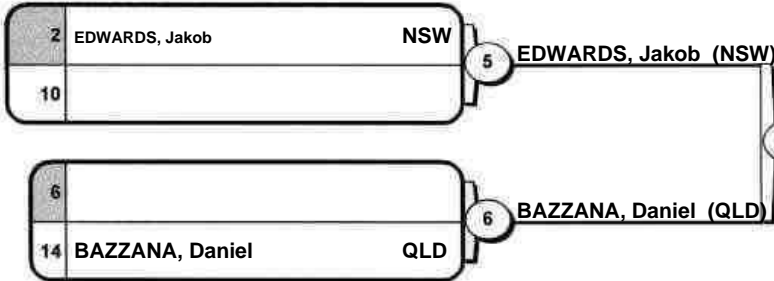

11 EDWARDS, Jakob (NSW)
10 / 00 0:29
Pool C - Winner
Vainqueur / Sieger

POOL D

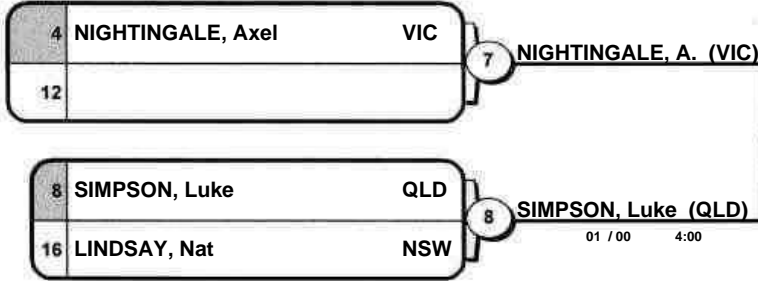

12 NIGHTINGALE, A. (VIC)
11 s2 / 00 s1 1:30
Pool D - Winner
Vainqueur / Sieger

OZCICEK-TAKAGI, K. (NSW)
10 s1 / 00 s1 1:45

1.

18 EDWARDS, Jakob (NSW)
11 s1 / 00 s1 3:33

Results

Résultat / Platzierungen

- | | |
|---------------------------|-----|
| 1. OZCICEK-TAKAGI, Kayhan | NSW |
| 2. EDWARDS, Jakob | NSW |
| 3. SPRULES, James | SA |
| 3. SWALWELL, Christopher | QLD |
| 5. NIGHTINGALE, Axel | VIC |
| 5. SIMPSON, Luke | QLD |
| 7. IMRAN, Hidayat | NSW |
| 7. BAZZANA, Daniel | QLD |

Repechage / Trostrunde

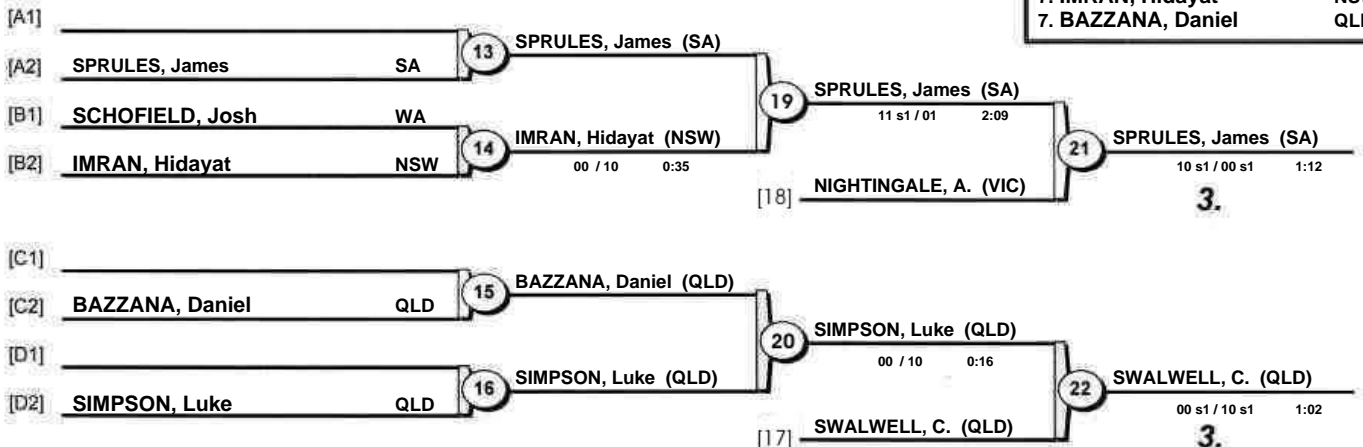

2022 Senior Men and Women Australian National Championships

Gold Coast (AUS), 12 Jun 2022

+100 kg

7 Judoka

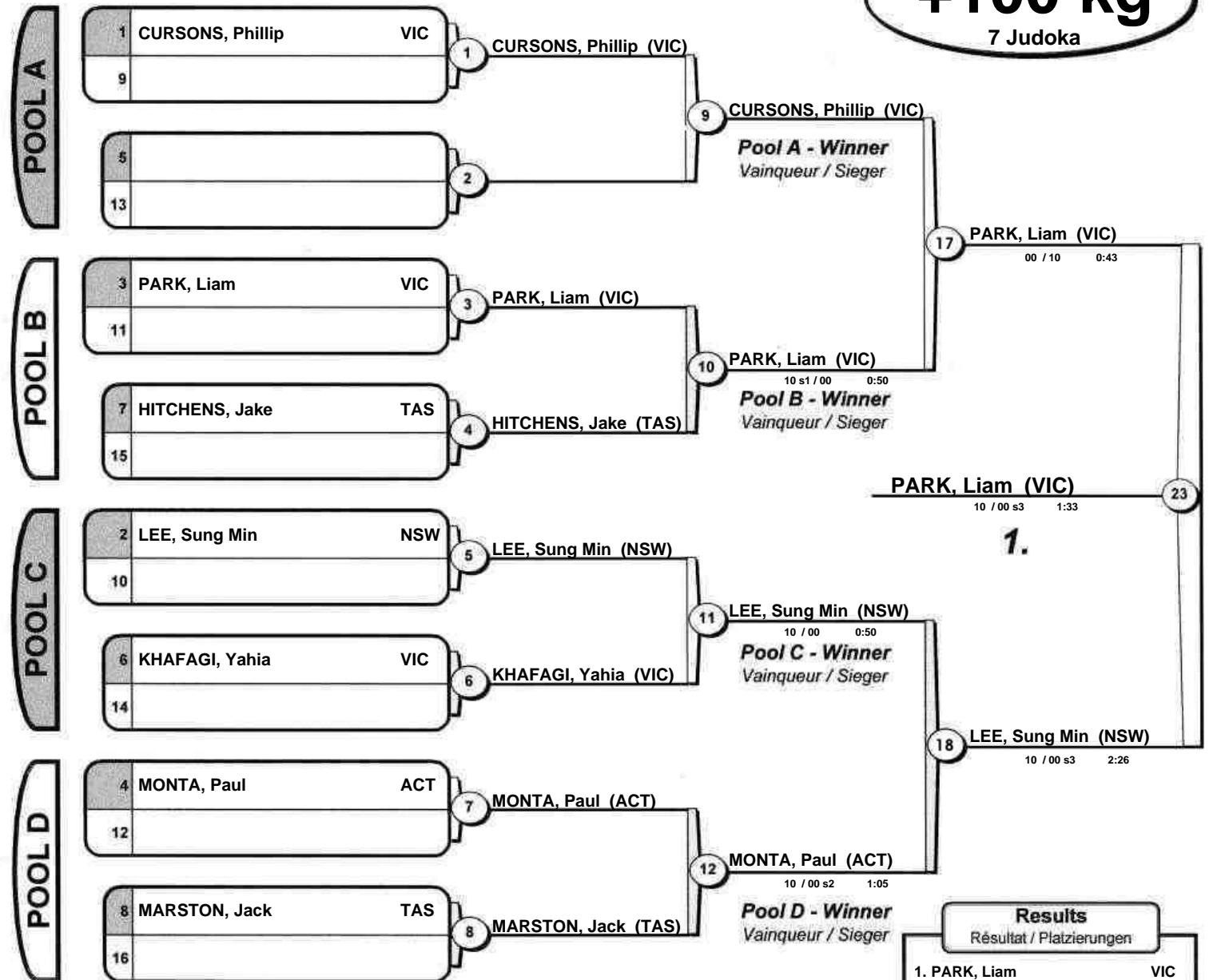

Results	
Résultat / Platzierungen	
1.	PARK, Liam VIC
2.	LEE, Sung Min NSW
3.	HITCHENS, Jake TAS
3.	CURSONS, Phillip VIC
5.	MONTA, Paul ACT
5.	MARSTON, Jack TAS
7.	KHAFAGI, Yahia VIC

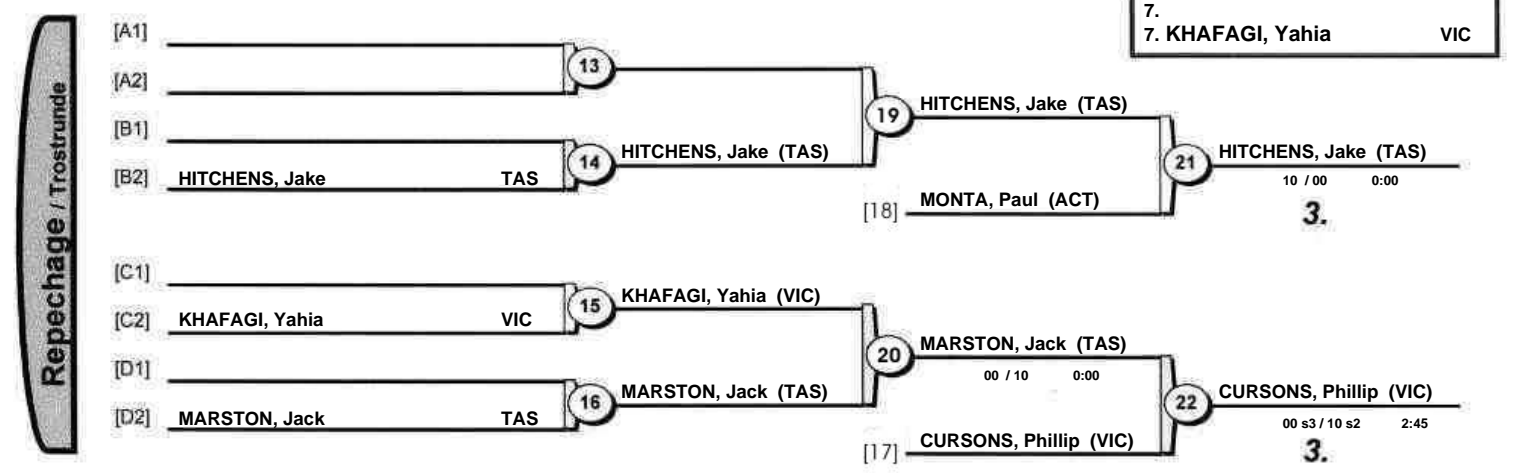

	1	2	3	Fights won	Place
				Total points	
OLSEN, Eran [SA]	0	0			3
	00000	00000			
HITCHENS, Jake [TAS]	1		1	2	1
	10000		01000	20	
MARSTON, Jack [TAS]		1	0	1	2
		02001	00002	10	

JUDO AUSTRALIA

2022 Judo Nationals
Monday, 13 June 2022
Weight category: Kyu Men -60 kg

-60 kg
 (11 competitors)

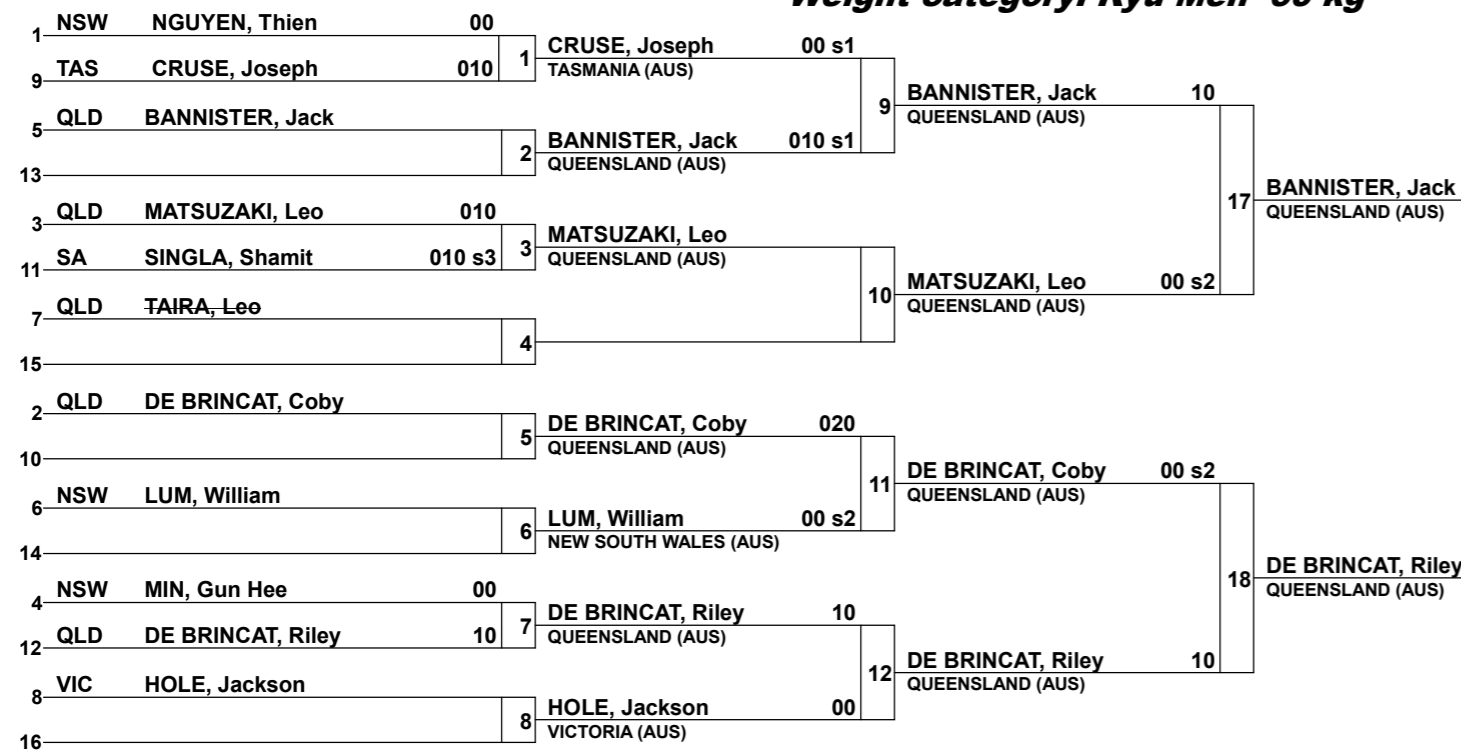

RESULTS		
1	BANNISTER, Jack	QLD
2	DE BRINCAT, Riley	QLD
3	DE BRINCAT, Coby	QLD
3	MATSUZAKI, Leo	QLD
5	CRUSE, Joseph	TAS
5	LUM, William	NSW
7	SINGLA, Shamit	SA
7		

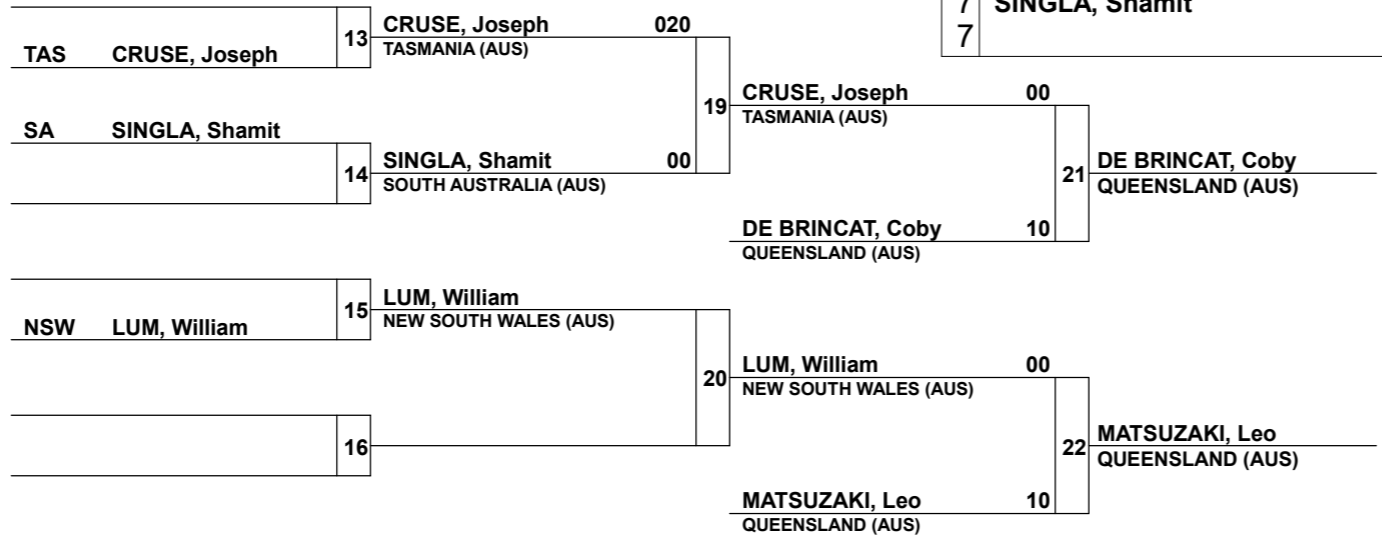

1	PEDLEY, Warrick WESTERN AUSTRALIA (AUS)	00 s1
5	FADIL, Nur NEW SOUTH WALES (AUS)	010 s2
3	BRIAN, Kim SOUTH AUSTRALIA (AUS)	00 s2
7	LEAVER, Seth QUEENSLAND (AUS)	010 s1
2	GARDINER, Lucas WESTERN AUSTRALIA (AUS)	00
6	SULTANA, Ben QUEENSLAND (AUS)	10
4	MAGNANINI, Luke QUEENSLAND (AUS)	010 s1
8	ATARBOLD, Unurmunkh NEW SOUTH WALES (AUS)	10

1	FADIL, Nur NEW SOUTH WALES (AUS)	10
2	LEAVER, Seth QUEENSLAND (AUS)	00 s1
3	SULTANA, Ben QUEENSLAND (AUS)	00 s2
4	ATARBOLD, U. NEW SOUTH WALES (AUS)	10

5	FADIL, Nur NEW SOUTH WALES (AUS)	00 s2
11	ATARBOLD, U. NEW SOUTH WALES (AUS)	10 s1

11 ATARBOLD, Unurmunkh
NEW SOUTH WALE. (AUS)

RESULTS		
1	ATARBOLD, Unurmunkh	NSW
2	FADIL, Nur	NSW
3	SULTANA, Ben	QLD
3	MAGNANINI, Luke	QLD

7	PEDLEY, Warrick WESTERN AUSTRALIA (AUS)	010
9	BRIAN, Kim SOUTH AUSTRALIA (AUS)	010
8	GARDINER, Lucas WESTERN AUSTRALIA (AUS)	00
10	MAGNANINI, Luke QUEENSLAND (AUS)	10

7	BRIAN, Kim SOUTH AUSTRALIA (AUS)	00 s1
9	SULTANA, Ben QUEENSLAND (AUS)	10
8	MAGNANINI, Luke QUEENSLAND (AUS)	010
10	LEAVER, Seth QUEENSLAND (AUS)	00

9 SULTANA, Ben
QUEENSLAND (AUS)

10 MAGNANINI, Luke
QUEENSLAND (AUS)

JUDO AUSTRALIA

2022 Judo Nationals
Monday, 13 June 2022
Weight category: Kyu Men -73 kg

-73 kg
 (10 competitors)

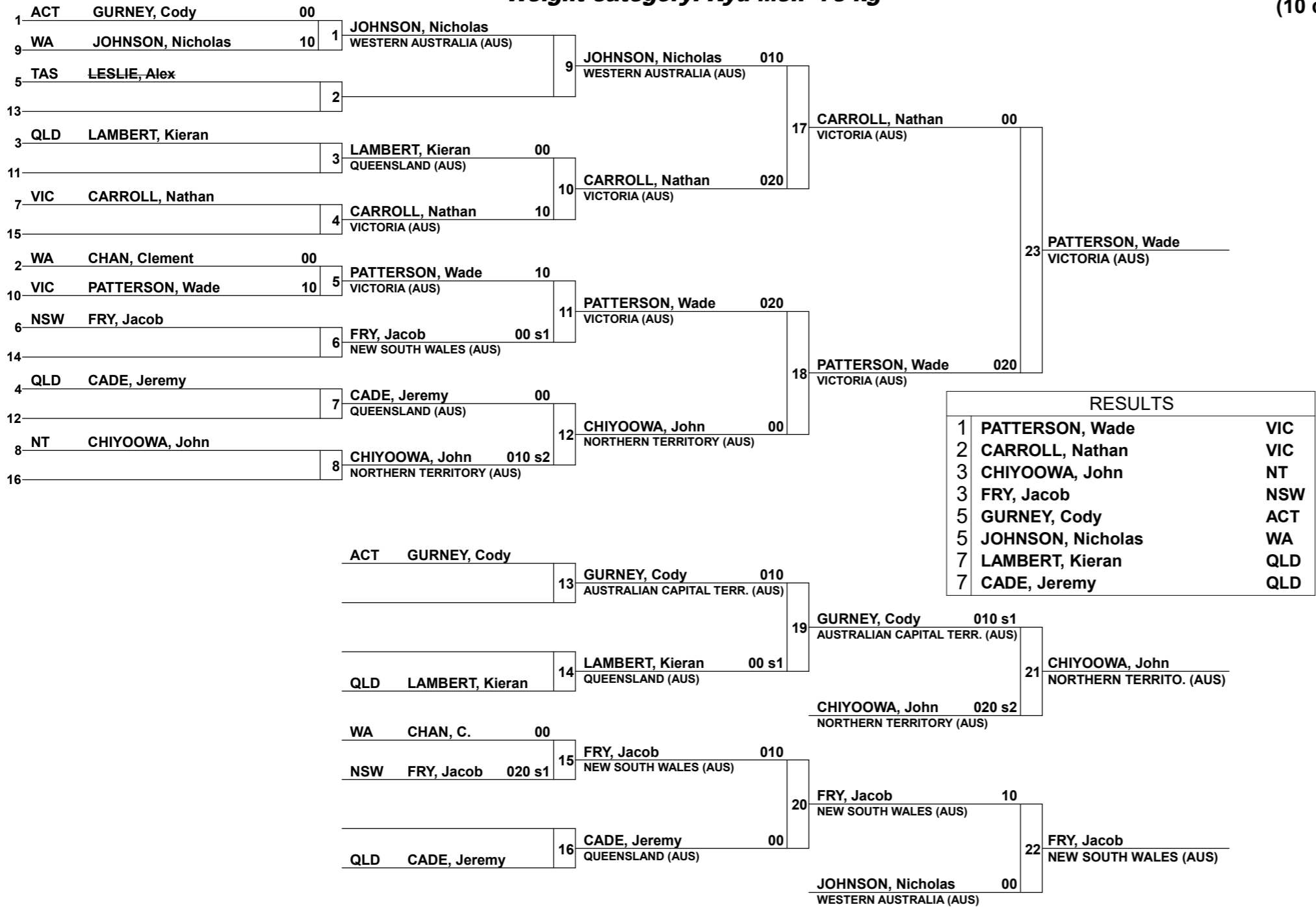

JUDO AUSTRALIA

2022 Judo Nationals
Monday, 13 June 2022
Weight category: Kyu Men -81 kg

-81 kg
(11 competitors)

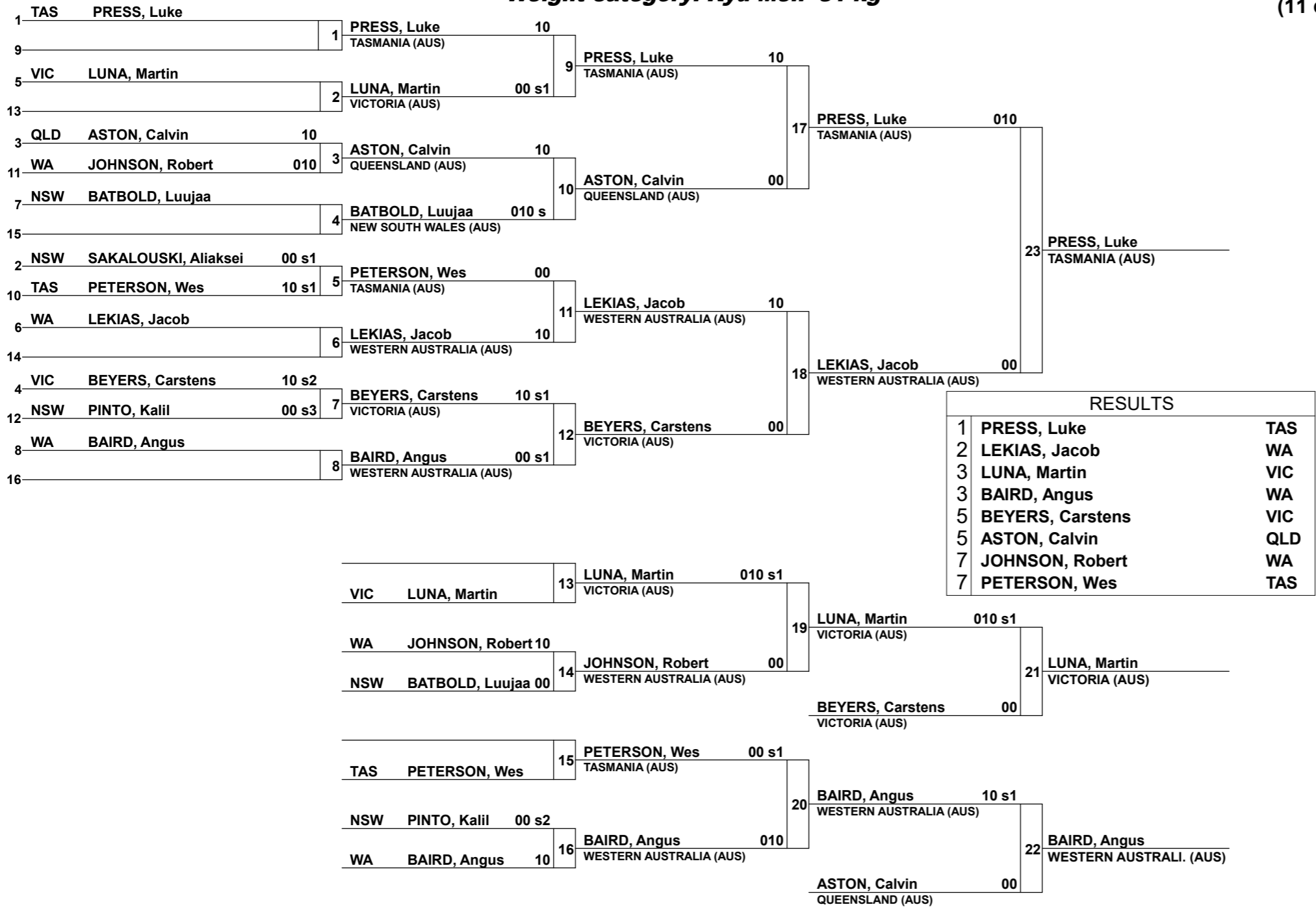

1	FITZGERALD, Michael	010	
	NORTHERN TERRITORY (AUS)		
5	HINSHELWOOD, John	00	
	QUEENSLAND (AUS)		
3	COPPLEMAN, Zachary	10	
	TASMANIA (AUS)		
7	ELKENHANS, Kyle	00	
	QUEENSLAND (AUS)		
2	PANAGOPOULOS, John	10	
	VICTORIA (AUS)		
6	TOMLIN, Lincoln	00	
	QUEENSLAND (AUS)		
4	SHIPTON, Joshua	10	
	WESTERN AUSTRALIA (AUS)		
8	KORIC, Kenan	00	
	QUEENSLAND (AUS)		

1	FITZGERALD, M.	00 s1
	NORTHERN TERRITORY (AUS)	

2	COPPLEMAN, Z.	010 s2
	TASMANIA (AUS)	

3	PANAGOPOULOS, John	00
	VICTORIA (AUS)	

4	SHIPTON, Joshua	10
	WESTERN AUSTRALIA (AUS)	

7	HINSHELWOOD, J.	020 s1
	QUEENSLAND (AUS)	

10	ELKENHANS, Kyle	010
	QUEENSLAND (AUS)	

00	TOMLIN, Lincoln	00
	QUEENSLAND (AUS)	

10	KORIC, Kenan	10
	QUEENSLAND (AUS)	

5	COPPLEMAN, Zachary	010
	TASMANIA (AUS)	

6	SHIPTON, Joshua	010
	WESTERN AUSTRALIA (AUS)	

7	HINSHELWOOD, John	00
	QUEENSLAND (AUS)	

010	PANAGOPOULOS, J.	010
	VICTORIA (AUS)	

020	KORIC, Kenan	020
	QUEENSLAND (AUS)	

00	FITZGERALD, Michael	00
	NORTHERN TERRITORY (AUS)	

11	SHIPTON, Joshua
	WESTERN AUSTRALIA (AUS)

RESULTS		
1	SHIPTON, Joshua	WA
2	COPPLEMAN, Zachary	TAS
3	PANAGOPOULOS, John	VIC
3	KORIC, Kenan	QLD

9	PANAGOPOULOS, John
	VICTORIA (AUS)

10	KORIC, Kenan
	QUEENSLAND (AUS)

1	NIGHTINGALE, Axel	10
	VICTORIA (AUS)	
5	IMRAN, Hidayat	00
	NEW SOUTH WALES (AUS)	
3	TOMLIN, Harrison	
	QUEENSLAND (AUS)	
7		
2	SCHOFIELD, Josh	10
	WESTERN AUSTRALIA (AUS)	
6	EAMES, Andrew	00
	QUEENSLAND (AUS)	
4	SIMPSON, Luke	
	QUEENSLAND (AUS)	
8		

1	NIGHTINGALE, Axel	10
	VICTORIA (AUS)	
5	NIGHTINGALE, Axel	10
	VICTORIA (AUS)	
2	TOMLIN, Harrison	00
	QUEENSLAND (AUS)	
3	SCHOFIELD, Josh	00 s1
	WESTERN AUSTRALIA (AUS)	
6	SIMPSON, Luke	00 s1
	QUEENSLAND (AUS)	
4	SIMPSON, Luke	10
	QUEENSLAND (AUS)	

5	NIGHTINGALE, Axel	10
	VICTORIA (AUS)	
11	NIGHTINGALE, Axel	
	VICTORIA (AUS)	
6	SIMPSON, Luke	00 s1
	QUEENSLAND (AUS)	

RESULTS		
1	NIGHTINGALE, Axel	VIC
2	SIMPSON, Luke	QLD
3	IMRAN, Hidayat	NSW
3	EAMES, Andrew	QLD

7	IMRAN, Hidayat	
	NEW SOUTH WALES (AUS)	

7	IMRAN, Hidayat	10
	NEW SOUTH WALES (AUS)	
9	IMRAN, Hidayat	
	NEW SOUTH WALE. (AUS)	
8	SCHOFIELD, Josh	00
	WESTERN AUSTRALIA (AUS)	

8	EAMES, Andrew	
	QUEENSLAND (AUS)	

8	EAMES, Andrew	010 s2
	QUEENSLAND (AUS)	
10	EAMES, Andrew	
	QUEENSLAND (AUS)	
10	TOMLIN, Harrison	00 s1
	QUEENSLAND (AUS)	

	1	2	3	Fights won	Place
				Total points	
GOSEN, Taylor [NSW]	1	0		1	2
	10000	00002		10	
AIESI, Georgia [WA]	0		0		3
	00000		01000		
BELANGER, Amanda [QLD]		1	1	2	1
		10001	10002	20	

JUDO AUSTRALIA
2022 Judo Nationals
Monday, 13 June 2022
Weight category: Kyu Women -48 kg

Contest	Name	Score	Score	Name	Time
---------	------	-------	-------	------	------

1 - 2	FREELAND, Cherese NORTHERN TERRITORY (AUS)	0	10	TOMLIN, Tayissa QUEENSLAND (AUS)	1:29
-------	---	---	----	-------------------------------------	------

1 - 2	FREELAND, Cherese NORTHERN TERRITORY (AUS)	0	10	TOMLIN, Tayissa QUEENSLAND (AUS)	0:55
-------	---	---	----	-------------------------------------	------

1 - 2	FREELAND, Cherese NORTHERN TERRITORY (AUS)			TOMLIN, Tayissa QUEENSLAND (AUS)	
-------	---	--	--	-------------------------------------	--

Score points: Ippon 100 / Wazaari 10 / Yuko 1 / Yusei gachi 0,5

Criteria to define the winner: better of 2 contests, if 1 - 1 the third match will decide

RESULTS		
1	TOMLIN, Tayissa	QLD
2	FREELAND, Cherese	NT

	1	2	3	Fights won	Place
				Total points	
FRY, Alyssa [WA]	0	1		1	2
	00001	01001		10	
TITANTI, Romani [NSW]	1		1	2	1
	02000		10000	20	
FUNG, Matle [NSW]		0	0		3
		00001	00000		

Pool A

		1	3	4		
1	[SA] WELLS, Susanne	0	0			3
		00000	00002			
3	[QLD] DOWELL, Gwyneth	1		1	2	1
		02000		02000	20	
5	[TAS] GOSNELL, Phoebe		1	0	1	2
			01001	01000	1	

RESULTS		
1	BERTA, Zsofia	WA
2	DOWELL, Gwyneth	QLD
3	NOLAN, Bella	QLD

1	[SA] WELLS, Susanne				
3	[QLD] DOWELL, Gwyneth	A	DOWELL, Gwyneth	00	
			QUEENSLAND (AUS)		
5	[TAS] GOSNELL, Phoebe				6
2	BERTA, Zsofia	10			
	WESTERN AUSTRALIA (AUS)				WESTERN AUSTRALIA (AUS)
4	NOLAN, Bella	00			5
	QUEENSLAND (AUS)				
			GOSNELL, Phoebe	00	QUEENSLAND (AUS)
			TASMANIA (AUS)		
			NOLAN, Bella	10	
			QUEENSLAND (AUS)		

1	BOULTBEE, Amy TASMANIA (AUS)	020 s1
5	ADAMS, Christina NEW SOUTH WALES (AUS)	00 s2
3	RAMETTA, Ryley VICTORIA (AUS)	
7		
2	WILLING, Carla TASMANIA (AUS)	020 s1
6	JOYCE, Alannah NORTHERN TERRITORY (AUS)	00
4	ANSKEY, Avalon VICTORIA (AUS)	
8		

1	BOULTBEE, Amy TASMANIA (AUS)	00
5	RAMETTA, Ryley VICTORIA (AUS)	020
7		
3	WILLING, Carla TASMANIA (AUS)	10
6	WILLING, Carla TASMANIA (AUS)	00
4	ANSKEY, Avalon VICTORIA (AUS)	00

5	RAMETTA, Ryley VICTORIA (AUS)	010
11	RAMETTA, Ryley VICTORIA (AUS)	
6	WILLING, Carla TASMANIA (AUS)	00

RESULTS		
1	RAMETTA, Ryley	VIC
2	WILLING, Carla	TAS
3	ADAMS, Christina	NSW
3	JOYCE, Alannah	NT

7	ADAMS, Christina NEW SOUTH WALES (AUS)	
---	--	--

7	ADAMS, Christina NEW SOUTH WALES (AUS)	10
9	ANSKEY, Avalon VICTORIA (AUS)	00

9	ADAMS, Christina NEW SOUTH WALE. (AUS)	
---	--	--

8	JOYCE, Alannah NORTHERN TERRITORY (AUS)	
---	---	--

8	JOYCE, Alannah NORTHERN TERRITORY (AUS)	020
10	BOULTBEE, Amy TASMANIA (AUS)	00

10	JOYCE, Alannah NORTHERN TERRI. (AUS)	
----	--	--

JUDO AUSTRALIA
2022 Judo Nationals
Monday, 13 June 2022

Weight category: VETERAN KYU Women F2 +78 kg

Contest	Name	Score	Score	Name	Time
---------	------	-------	-------	------	------

1 - 2	WILLING, Carla TASMANIA (AUS)	0	10	BELANGER, Amanda QUEENSLAND (AUS)	1:13
-------	----------------------------------	---	----	--------------------------------------	------

1 - 2	WILLING, Carla TASMANIA (AUS)	0	10	BELANGER, Amanda QUEENSLAND (AUS)	2:48
-------	----------------------------------	---	----	--------------------------------------	------

1 - 2	WILLING, Carla TASMANIA (AUS)			BELANGER, Amanda QUEENSLAND (AUS)	
-------	----------------------------------	--	--	--------------------------------------	--

Score points: Ippon 100 / Wazaari 10 / Yuko 1 / Yusei gachi 0,5

Criteria to define the winner: better of 2 contests, if 1 - 1 the third match will decide

RESULTS		
1	BELANGER, Amanda	QLD
2	WILLING, Carla	TAS

JUDO AUSTRALIA
2022 Judo Nationals
Monday, 13 June 2022
Weight category: VETERAN KYU MEN M2 -90 kg

Contest	Name	Score	Score	Name	Time
1 - 2	PANAGOPOULOS, John VICTORIA (AUS)	10	0	HINSHELWOOD, John QUEENSLAND (AUS)	1:30
1 - 2	PANAGOPOULOS, John VICTORIA (AUS)	10	0	HINSHELWOOD, John QUEENSLAND (AUS)	0:15
1 - 2	PANAGOPOULOS, John VICTORIA (AUS)			HINSHELWOOD, John QUEENSLAND (AUS)	

Score points: Ippon 100 / Wazaari 10 / Yuko 1 / Yusei gachi 0,5

Criteria to define the winner: better of 2 contests, if 1 - 1 the third match will decide

RESULTS		
1	PANAGOPOULOS, John	VIC
2	HINSHELWOOD, John	QLD

	1	2	3	Fights won	Place
				Total points	
FADIL, Nur [NSW]	0	1		1	2
	00000	02000		10	
CHAN, Clement [WA]	1		1	2	1
	10000		10000	20	
CADE, Jeremy [QLD]		0	0		3
		00000	00000		

	1	2	3	Fights won	Place
				Total points	
SAKALOUSKI, Aliaksei [NSW]	1	0		1	2
	01000	00000		1	
PETERSON, Wes [TAS]	0		0		3
	00002		00000		
LEKIAS, Jacob [WA]		1	1	2	1
		10000	10000	20	

JUDO AUSTRALIA
2022 Judo Nationals
Monday, 13 June 2022
Weight category: VETERAN KYU MEN M3 -100 kg

Contest	Name	Score	Score	Name	Time
---------	------	-------	-------	------	------

1 - 2	IMRAN, Hidayat NEW SOUTH WALES (AUS)	10	0	EAMES, Andrew QUEENSLAND (AUS)	1:22
-------	---	----	---	-----------------------------------	------

1 - 2	IMRAN, Hidayat NEW SOUTH WALES (AUS)	10	0	EAMES, Andrew QUEENSLAND (AUS)	0:01
-------	---	----	---	-----------------------------------	------

1 - 2	IMRAN, Hidayat NEW SOUTH WALES (AUS)			EAMES, Andrew QUEENSLAND (AUS)	
-------	---	--	--	-----------------------------------	--

Score points: Ippon 100 / Wazaari 10 / Yuko 1 / Yusei gachi 0,5

Criteria to define the winner: better of 2 contests, if 1 - 1 the third match will decide

RESULTS		
1	IMRAN, Hidayat	NSW
2	EAMES, Andrew	QLD

JUDO AUSTRALIA
2022 Judo Nationals
Monday, 13 June 2022
Weight category: VETERAN KYU MEN M5 -66 kg

Contest	Name	Score	Score	Name	Time
1 - 2	LUM, William NEW SOUTH WALES (AUS)	10	0	MORRIS, Derek AUSTRALIAN CAPITAL TERRITORY (AUS)	5:39
1 - 2	LUM, William NEW SOUTH WALES (AUS)	0	10	MORRIS, Derek AUSTRALIAN CAPITAL TERRITORY (AUS)	2:17
1 - 2	LUM, William NEW SOUTH WALES (AUS)	10	0	MORRIS, Derek AUSTRALIAN CAPITAL TERRITORY (AUS)	5:14

Score points: Ippon 100 / Wazaari 10 / Yuko 1 / Yusei gachi 0,5

Criteria to define the winner: better of 2 contests, if 1 - 1 the third match will decide

RESULTS		
1	LUM, William	NSW
2	MORRIS, Derek	ACT

JUDO AUSTRALIA
2022 Judo Nationals
Monday, 13 June 2022
Weight category: VETERAN KYU MEN M5 -73 kg

Contest	Name	Score	Score	Name	Time
1 - 2	VAN DORT, Conrad NEW SOUTH WALES (AUS)	0	10	NOLAN, Robert QUEENSLAND (AUS)	1:08
1 - 2	VAN DORT, Conrad NEW SOUTH WALES (AUS)	0	10	NOLAN, Robert QUEENSLAND (AUS)	0:18
1 - 2	VAN DORT, Conrad NEW SOUTH WALES (AUS)			NOLAN, Robert QUEENSLAND (AUS)	

Score points: Ippon 100 / Wazaari 10 / Yuko 1 / Yusei gachi 0,5

Criteria to define the winner: better of 2 contests, if 1 - 1 the third match will decide

RESULTS		
1	NOLAN, Robert	QLD
2	VAN DORT, Conrad	NSW

	1	2	3	Fights won	Place
				Total points	
FINLEY, Joe [WA]	0	1		1	2
	01000	01001		10	
DOWDEN, Brent [QLD]	1		1	2	1
	10000		10000	20	
BARNES, Grant [TAS]		0	0		3
		00000	00000		

	1	2	3	Fights won	Place
				Total points	
HODSON, Mark [QLD]	1	1		2	1
	01001	10002		11	
YOUNG, Scott [NSW]	0		0		3
	00002		00000		
RAMETTA, Bernie [VIC]		0	1	1	2
		00003	02000	10	

	1	2	3	Fights won	Place
				Total points	
MISIUN, Slawek [WA]	0	0			3
	00002	00000			
HARGRAVES, Andrew [QLD]	1		0	1	2
	01001		00000	10	
OLSEN, Eran [SA]		1	1	2	1
		01000	10000	11	

JUDO AUSTRALIA
2022 Judo National Championships Veterans
Monday, 13 June 2022
Weight category: Veteran Women +78 kg

Contest	Name	Score	Score	Name	Time
1 - 2	HARUMI MOROMIZATO, Karine QUEENSLAND (AUS)	10	0	BELANGER, Amanda QUEENSLAND (AUS)	3:27
1 - 2	HARUMI MOROMIZATO, Karine QUEENSLAND (AUS)	10	0	BELANGER, Amanda QUEENSLAND (AUS)	4:31
1 - 2	HARUMI MOROMIZATO, Karine QUEENSLAND (AUS)			BELANGER, Amanda QUEENSLAND (AUS)	

Score points: Ippon 100 / Wazaari 10 / Yuko 1 / Yusei gachi 0,5

Criteria to define the winner: better of 2 contests, if 1 - 1 the third match will decide

RESULTS		
1	HARUMI MOROMIZATO, Karine	QLD
2	BELANGER, Amanda	QLD

JUDO AUSTRALIA
2022 Judo National Championships Veterans
Monday, 13 June 2022
Weight category: Veteran Women -52 kg

Contest	Name	Score	Score	Name	Time
1 - 2	FUNG, Matle NEW SOUTH WALES (AUS)	0	10	HAYASHI, Yumiko QUEENSLAND (AUS)	0:41
1 - 2	FUNG, Matle NEW SOUTH WALES (AUS)	0	10	HAYASHI, Yumiko QUEENSLAND (AUS)	0:51
1 - 2	FUNG, Matle NEW SOUTH WALES (AUS)			HAYASHI, Yumiko QUEENSLAND (AUS)	

Score points: Ippon 100 / Wazaari 10 / Yuko 1 / Yusei gachi 0,5

Criteria to define the winner: better of 2 contests, if 1 - 1 the third match will decide

RESULTS		
1	HAYASHI, Yumiko	QLD
2	FUNG, Matle	NSW

	1	2	3	Fights won	Place
				Total points	
WILLING, Carla [TAS]	0	1		1	2
	00000	02000		10	
BALLARINI, Mara [QLD]	1		1	2	1
	10000		02000	20	
ABOUZEID, Maysa [VIC]		0	0		3
		00000	00000		

RESULTS		
1	ANTUN NETO, Pedro	NSW
2	ATARBOLD, Unurmunkh	NSW
3	JONES, Luke	QLD

1	JONES, Luke QUEENSLAND (AUS)	00 s2	1	ATARBOLD, Unurmunkh NEW SOUTH WALES (AUS)	00 s3	4	ANTUN NETO, Pedro NEW SOUTH WALES (AUS)
3	ATARBOLD, Unurmunkh NEW SOUTH WALES (AUS)	010 s1	2	ANTUN NETO, Pedro NEW SOUTH WALES (AUS)	10 s1	3	JONES, Luke QUEENSLAND (AUS)
2	WILLING, Lewis TASMANIA (AUS)	00	3	WILLING, Lewis TASMANIA (AUS)	00 s1		
4	ANTUN NETO, Pedro NEW SOUTH WALES (AUS)	10					

	1	2	3	Fights won	Place
				Total points	
MURPHY, Sebastian [QLD]	1	1		2	1
	10000	10000		20	
LEE, Thomas [VIC]	0		0		3
	00000		00000		
FADIL, Nur [NSW]		0	1	1	2
		00000	01002	1	

RESULTS		
1	ROBERTS, Andrew	NSW
2	ABDO, Ahmed	NSW
3	CHAN, Clement	WA

1 **CHAN, Clement** 00
 WESTERN AUSTRALIA (AUS)

3 **ROBERTS, Andrew** 020
 NEW SOUTH WALES (AUS)

2 **CADE, Jeremy** 00
 QUEENSLAND (AUS)

4 **ABDO, Ahmed** 020
 NEW SOUTH WALES (AUS)

1 **ROBERTS, Andrew** 10
 NEW SOUTH WALES (AUS)

2 **ABDO, Ahmed** 00
 NEW SOUTH WALES (AUS)

CHAN, Clement 020
 WESTERN AUSTRALIA (AUS)

CADE, Jeremy 00
 QUEENSLAND (AUS)

4 **ROBERTS, Andrew**
 NEW SOUTH WALES (AUS)

3 **CHAN, Clement**
 WESTERN AUSTRALIA (AUS)

RESULTS		
1	LEKIAS, Jacob	WA
2	PINTO, Kalil	NSW
3	STUART, Luke	QLD

1	PINTO, Kalil NEW SOUTH WALES (AUS)	10 s2	1	PINTO, Kalil NEW SOUTH WALES (AUS)	00	4	LEKIAS, Jacob WESTERN AUSTRALIA (AUS)
3	STUART, Luke QUEENSLAND (AUS)	00 s2	2	LEKIAS, Jacob WESTERN AUSTRALIA (AUS)	020 s1	3	STUART, Luke QUEENSLAND (AUS)
2	POLANKAI, Hugo VICTORIA (AUS)	00		STUART, Luke QUEENSLAND (AUS)	020		POLANKAI, Hugo VICTORIA (AUS)
4	LEKIAS, Jacob WESTERN AUSTRALIA (AUS)	020					

Pool A

		1	3	4		
1	[SA] ALBER, Christian	1	1		2	1
		02000	10000		20	
3	[NT] FITZGERALD, Michael	0		1	1	2
		00000		10000	10	
5	[VIC] PANAGOPOULOS, John		0	0		3
			00000	00000		

RESULTS		
1	ALBER, Christian	SA
2	MCLAREN, Hamish	TAS
3	FITZGERALD, Michael	NT

1	[SA] ALBER, Christian				
3	[NT] FITZGERALD, Michael	A	ALBER, Christian	010	
5	[VIC] PANAGOPOULOS, John		SOUTH AUSTRALIA (AUS)		
2	FAKAOSI, Feao NEW SOUTH WALES (AUS)	00			6
4	MCLAREN, Hamish TASMANIA (AUS)	10	MCLAREN, Hamish	010	
			FITZGERALD, Michael	020	5
			NORTHERN TERRITORY (AUS)		
			FAKAOSI, Feao	00	FITZGERALD, Michael
			NEW SOUTH WALES (AUS)		NORTHERN TERRITOR. (AUS)

RESULTS		
1	MCCORMACK, Colm	QLD
2	SCHOFIELD, Josh	WA
3	HARGRAVES, Andrew	QLD

1	SCHOFIELD, Josh WESTERN AUSTRALIA (AUS)	10	1	SCHOFIELD, Josh WESTERN AUSTRALIA (AUS)	00 s1	4	MCCORMACK, Colm QUEENSLAND (AUS)
3	HARGRAVES, Andrew QUEENSLAND (AUS)	00	2	MCCORMACK, Colm QUEENSLAND (AUS)	020 s2	3	HARGRAVES, Andrew QUEENSLAND (AUS)
2	IMRAN, Hidayat NEW SOUTH WALES (AUS)	00 s1	4	MCCORMACK, Colm QUEENSLAND (AUS)	10 s1	3	HARGRAVES, Andrew QUEENSLAND (AUS)
4	MCCORMACK, Colm QUEENSLAND (AUS)	10 s1	3	IMRAN, Hidayat NEW SOUTH WALES (AUS)	010		

	1	2	3	Fights won	Place
				Total points	
LUM, William [NSW]	0	0			3
	00001	00000			
TOURNIER, Luc [WA]	1		1	2	1
	02000		10000	20	
WONG, Danny [WA]		1	0	1	2
		02000	00000	10	

RESULTS		
1	LEGAUD, Christophe	VIC
2	BERTA, Andras	WA
3	NOLAN, Robert	QLD

1	LEGAUD, Christophe VICTORIA (AUS)	10	1	LEGAUD, Christophe VICTORIA (AUS)	10 s1
3	FILMER, Aaron QUEENSLAND (AUS)	00 s2	4	LEGAUD, Christophe VICTORIA (AUS)	
2	BERTA, Andras WESTERN AUSTRALIA (AUS)	020 s1	2	BERTA, Andras WESTERN AUSTRALIA (AUS)	00 s3
4	NOLAN, Robert QUEENSLAND (AUS)	00	3	NOLAN, Robert QUEENSLAND (AUS)	
				FILMER, Aaron QUEENSLAND (AUS)	00
				NOLAN, Robert QUEENSLAND (AUS)	10

	1	2	3	Fights won	Place
				Total points	
ARZHINTAR, Igor [VIC]	1	0		1	2
	02000	00000		10	
CARAVELLO, Dario [QLD]	0		0		3
	00001		00000		
SAKALOUSKI, Aliaksei [NSW]		1	1	2	1
		10000	10001	20	

	1	2	3	Fights won	Place
				Total points	
MITCHELL, Tim [QLD]	1	1		2	1
	01002	10000		20	
NAE, Ionut [WA]	0		0		3
	00001		00000		
FINLEY, Joe [WA]		0	1	1	2
		00000	01000	10	

1	VAN DORT, Conrad NEW SOUTH WALES (AUS)	
5		
3	SCHROEDER, Adam QUEENSLAND (AUS)	00 s1
7	CASAS, Omar VICTORIA (AUS)	10 s1
2	WATKINS, John AUSTRALIAN CAPITAL TERRITO. (AUS)	00
6	HOBBY, Brenton SOUTH AUSTRALIA (AUS)	10
4	CONRAN, Carl QUEENSLAND (AUS)	
8		

1	VAN DORT, Conrad NEW SOUTH WALES (AUS)	00 s1
---	---	-------

5	CASAS, Omar VICTORIA (AUS)	00
---	-------------------------------	----

2	CASAS, Omar VICTORIA (AUS)	020
---	-------------------------------	-----

11	HOBBY, Brenton SOUTH AUSTRALIA (AUS)
----	---

3	HOBBY, Brenton SOUTH AUSTRALIA (AUS)	020
---	---	-----

6	HOBBY, Brenton SOUTH AUSTRALIA (AUS)	10
---	---	----

4	CONRAN, Carl QUEENSLAND (AUS)	00
---	----------------------------------	----

RESULTS		
1	HOBBY, Brenton	SA
2	CASAS, Omar	VIC
3	CONRAN, Carl	QLD
3	WATKINS, John	ACT

7	SCHROEDER, Adam QUEENSLAND (AUS)
---	-------------------------------------

7	SCHROEDER, Adam QUEENSLAND (AUS)	00
---	-------------------------------------	----

9	CONRAN, Carl QUEENSLAND (AUS)
---	----------------------------------

10	CONRAN, Carl QUEENSLAND (AUS)
----	----------------------------------

8	WATKINS, John AUSTRALIAN CAPITAL T. (AUS)
---	--

8	WATKINS, John AUSTRALIAN CAPITAL T. (AUS)	10 s1
---	--	-------

10	WATKINS, John AUSTRALIAN CAPI. (AUS)
----	---

10	VAN DORT, Conrad NEW SOUTH WALES (AUS)	00 s3
----	---	-------

Pool A

		1	3	4		
1	[QLD] BELL, Andrew	0	1		1	2
		00002	10000		10	
3	[VIC] RAMETTA, Bernie	1		1	2	1
		01000		02000	11	
5	[NSW] YOUNG, Scott		0	0		3
			00000	00000		

RESULTS		
1	ODEA, Martin	WA
2	RAMETTA, Bernie	VIC
3	BELL, Andrew	QLD

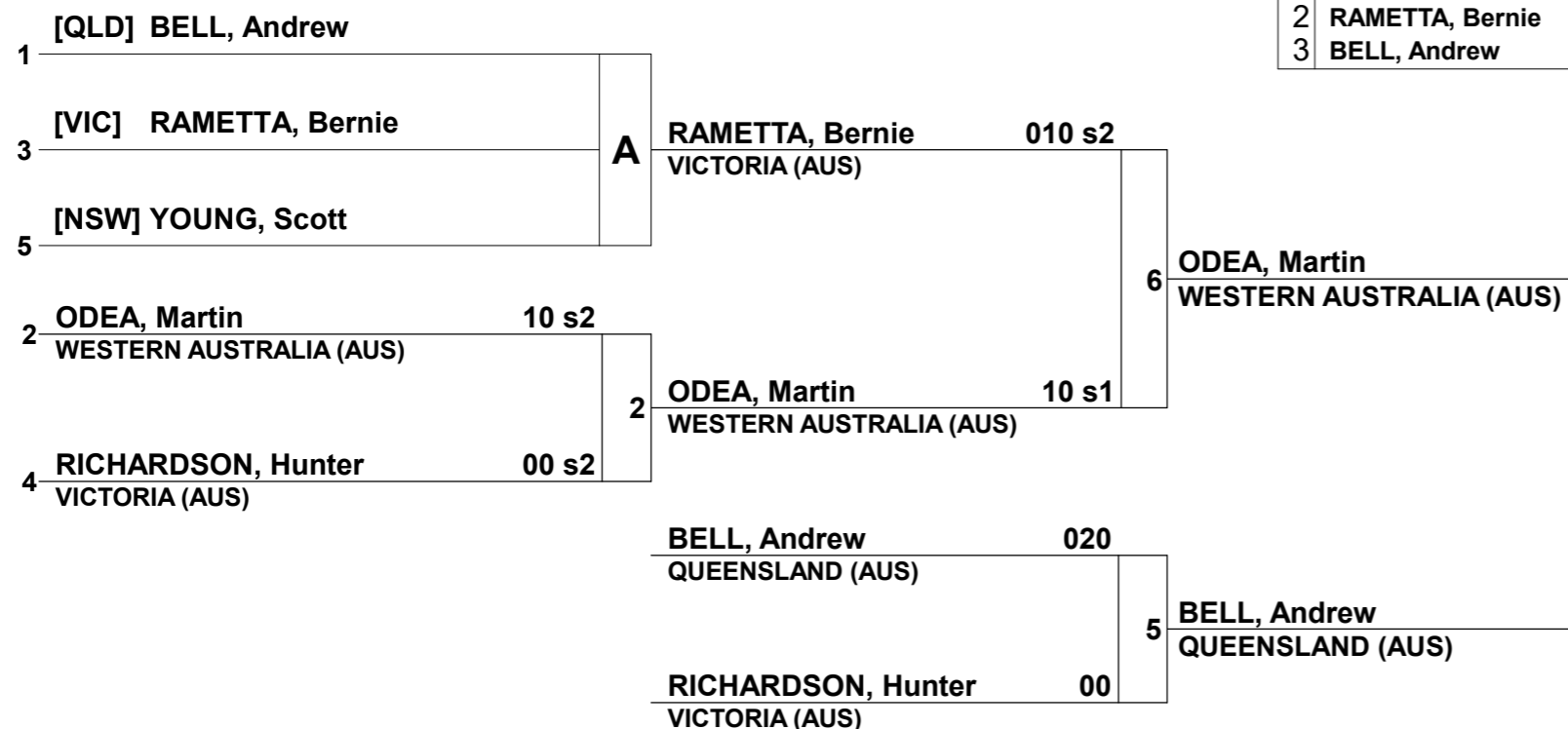

RESULTS		
1	SCHMIDT, Andreas	QLD
2	BATTINO, John	QLD
3	BARNES, Grant	TAS

1	BATTINO, John QUEENSLAND (AUS)	10 s1	1	BATTINO, John QUEENSLAND (AUS)	00
3	SIMMONDS, Clive NEW SOUTH WALES (AUS)	00	4	SCHMIDT, Andreas QUEENSLAND (AUS)	
2	BARNES, Grant TASMANIA (AUS)	00	2	SCHMIDT, Andreas QUEENSLAND (AUS)	010
4	SCHMIDT, Andreas QUEENSLAND (AUS)	10		SIMMONDS, Clive NEW SOUTH WALES (AUS)	00
			3	BARNES, Grant TASMANIA (AUS)	
				BARNES, Grant TASMANIA (AUS)	010 s1

RESULTS		
1	MCKENZIE, Ken	NSW
2	AZOURY, John	ACT
3	REDPATH, Vincent	WA

1	AZOURY, John	010 s2	AUSTRALIAN CAPITAL TERRITORY (AUS)	1	AZOURY, John	00	AUSTRALIAN CAPITAL TERRITORY (AUS)	4	MCKENZIE, Ken	NEW SOUTH WALES (AUS)
3	REDPATH, Vincent	00 s3	WESTERN AUSTRALIA (AUS)	2	MCKENZIE, Ken	010	NEW SOUTH WALES (AUS)	3	REDPATH, Vincent	WESTERN AUSTRALIA (AUS)
2	MCKENZIE, Ken	010	NEW SOUTH WALES (AUS)	4	MORRIS, Derek	00	AUSTRALIAN CAPITAL TERRITORY (AUS)			
					REDPATH, Vincent	10	WESTERN AUSTRALIA (AUS)			
					MORRIS, Derek	00	AUSTRALIAN CAPITAL TERRITORY (AUS)			

JUDO AUSTRALIA
2022 Judo National Championships Veterans
Monday, 13 June 2022
Weight category: Veteran Men V7 -100 kg

Contest	Name	Score	Score	Name	Time
1 - 2	MISIUN, Slawek WESTERN AUSTRALIA (AUS)	0	10	NABULSI, David VICTORIA (AUS)	0:29
1 - 2	MISIUN, Slawek WESTERN AUSTRALIA (AUS)	0	10	NABULSI, David VICTORIA (AUS)	1:35
1 - 2	MISIUN, Slawek WESTERN AUSTRALIA (AUS)			NABULSI, David VICTORIA (AUS)	

Score points: Ippon 100 / Wazaari 10 / Yuko 1 / Yusei gachi 0,5

Criteria to define the winner: better of 2 contests, if 1 - 1 the third match will decide

RESULTS		
1	NABULSI, David	VIC
2	MISIUN, Slawek	WA

JUDO AUSTRALIA
2022 Judo Nationals No Limits
12th & 13th June 2022
Weight category: No Limits Juniors -46 kg

Contest	Name	Score	Score	Name	Time
1 - 2	ANDERSON, Rikki QUEENSLAND (AUS)	0	10	GITTUS, Huntar TASMANIA (AUS)	0:04
1 - 2	ANDERSON, Rikki QUEENSLAND (AUS)	10	0	GITTUS, Huntar TASMANIA (AUS)	0:04
1 - 2	ANDERSON, Rikki QUEENSLAND (AUS)	0	10	GITTUS, Huntar TASMANIA (AUS)	0:04

Score points: Ippon 100 / Wazaari 10 / Yuko 1 / Yusei gachi 0,5

Criteria to define the winner: better of 2 contests, if 1 - 1 the third match will decide

RESULTS		
1	GITTUS, Huntar	TAS
2	ANDERSON, Rikki	QLD

JUDO AUSTRALIA
2022 Judo Nationals No Limits
12th & 13th June 2022
 Weight category: No Limit Men -90 kg

	Name	Nation	Fill in winning score			Wins	Points	Place
			1	2	3			
1	GIRDWOOD, Robert [WESTERN AUSTRALIA (AUS)]	WA		10	0	1	10	2
2	SAMPSON, Tobias [TASMANIA (AUS)]	TAS	0		0	0	0	3
3	TANDEAN, Bernhard [NEW SOUTH WALES (AUS)]	NSW	10	10		2	20	1

Order of Contests: 1 - 2 / 1 - 3 / 2 - 3

Contest	Name	Score	Score	Name	Time
1 - 2	GIRDWOOD, Robert WESTERN AUSTRALIA (AUS)	10	0	SAMPSON, Tobias TASMANIA (AUS)	0:04
1 - 3	GIRDWOOD, Robert WESTERN AUSTRALIA (AUS)	0	10	TANDEAN, Bernhard NEW SOUTH WALES (AUS)	0:04
2 - 3	SAMPSON, Tobias TASMANIA (AUS)	0	10	TANDEAN, Bernhard NEW SOUTH WALES (AUS)	0:04

Score points: Ippon 10 / Waza-ari 1 / Penalties 0

RESULTS		
1	TANDEAN, Bernhard	NSW
2	GIRDWOOD, Robert	WA
3	SAMPSON, Tobias	TAS

JUDO AUSTRALIA
2022 Judo Nationals No Limits
12th & 13th June 2022
Weight category: No Limits Juniors -30 kg

Contest	Name	Score	Score	Name	Time
1 - 2	GITTUS, James TASMANIA (AUS)	10	0	NASSAR, Tailya VICTORIA (AUS)	0:04
1 - 2	GITTUS, James TASMANIA (AUS)	0	10	NASSAR, Tailya VICTORIA (AUS)	0:04
1 - 2	GITTUS, James TASMANIA (AUS)	0	10	NASSAR, Tailya VICTORIA (AUS)	0:04

Score points: Ippon 100 / Wazaari 10 / Yuko 1 / Yusei gachi 0,5

Criteria to define the winner: better of 2 contests, if 1 - 1 the third match will decide

RESULTS		
1	NASSAR, Tailya	VIC
2	GITTUS, James	TAS

	1	2	3	Fights won	Place
				Total points	
GOSEN, Taylor [NSW]	1	1		2	1
	10000	10000		20	
ODONNELL, Rebeccah [QLD]	0		0		3
	00000		01000		
ABOUZEID, Maysa [VIC]		0	1	1	2
		00001	01000	10	

RESULTS		
1	LADLOW, Phoebe	TAS
2	MCCREDDEN, Lynne	NSW
3	ABOUZEID, Maysa	VIC

1	ABOUZEID, Maysa VICTORIA (AUS)	00	1	LADLOW, Phoebe TASMANIA (AUS)	020
3	LADLOW, Phoebe TASMANIA (AUS)	10	4	LADLOW, Phoebe TASMANIA (AUS)	
2	DUNN, Casey WESTERN AUSTRALIA (AUS)	00	2	MCCREDDEN, Lynne NEW SOUTH WALES (AUS)	00
4	MCCREDDEN, Lynne NEW SOUTH WALES (AUS)	10	3	ABOUZEID, Maysa VICTORIA (AUS)	10
				DUNN, Casey WESTERN AUSTRALIA (AUS)	00

	1	2	3	Fights won	Place
				Total points	
GOSEN, Taylor [NSW]	1	1		2	1
	01000	10000		20	
ABOUZEID, Maysa [VIC]	0		0		3
	00000		00000		
LADLOW, Phoebe [TAS]		0	1	1	2
		00000	01000	10	

JUDO AUSTRALIA
2022 Judo Nationals No Limits
12th & 13th June 2022
Weight category: No Limits Women -78 kg

Contest	Name	Score	Score	Name	Time
1 - 2	MCCREDDEN, Lynne NEW SOUTH WALES (AUS)	0	10	LADLOW, Phoebe TASMANIA (AUS)	0:04
1 - 2	MCCREDDEN, Lynne NEW SOUTH WALES (AUS)	0	10	LADLOW, Phoebe TASMANIA (AUS)	0:04
1 - 2	MCCREDDEN, Lynne NEW SOUTH WALES (AUS)			LADLOW, Phoebe TASMANIA (AUS)	

Score points: Ippon 100 / Wazaari 10 / Yuko 1 / Yusei gachi 0,5





Criteria to define the winner: better of 2 contests, if 1 - 1 the third match will decide

RESULTS		
1	LADLOW, Phoebe	TAS
2	MCCREDDEN, Lynne	NSW







Nage No Kata

 WA	READ Simon - READ Jacob	372.0
 NSW	TANDEAN Bernhard - TANDEAN Bianca	332.0
 VIC	RICHARDSON Hunter - NABULSI David	322.5
 QLD	MOROMIZATO Karine Harumi - PAZ LANDIN Lorivaldo Junior	301.0
 ACT	MORRIS Derek - DAQUINO Matthew	258.0
 NSW	BOYD Katelyn - FUNG Matle	222.5

Nage No Kata - 3G

 NSW	XU Aaron - CAI Demin	198.5
 SA	BRUNET-GRESEQUE Tom - BOWDEN-SMIT Reuben	194.0
 WA	WADE Oliver - KRAMER Ella	184.5
 NSW	TURNER Gabrielle - TURNER Annelise	180.0
 WA	BARFORD Chloe - KULFALOVSKI Mila	175.0

Katame No Kata



 NSW	MALINOWSKA Yekaterina - MALINOWSKI Alexander	384.5
 NSW	TANDEAN Bernhard - TANDEAN Bjorn	384.0
 TAS	WAKAMATSU Yutaka - MACKEY Nicholas	383.5
 VIC	RICHARDSON Hunter - NABULSI David	366.0
 QLD	BARKER Xavier - ANDJELKOVIC Srdjan	357.5
 NSW	CADORIN Greg - HOLMES Mathew	354.5
 QLD	MITCHELL Tim - RASMUSSEN Anna	230.0

Ju-No Kata







 SA	SMITH Scott - LEWIS Richard	360.5
---	------------------------------------	--------------

 NSW	TANDEAN Bernhard - TANDEAN Bianca	356.0
--	--	--------------

Kime No Kata

 SA	MOTOYAMA Masahiko - TRAN Binh	485.5
 NSW	MALINOWSKI Alexander - MALINOWSKA Yekaterina	449.5
 NSW	WANG Louis - YUEN Edmund	435.5

Goshin Jutsu

 NSW	HOLMES Mathew - CADORIN Greg	497.0
 QLD	MURPHY Kevin - MURPHY Sebastian	482.5
 QLD	MANU Sam - PHOUPHAYLY Palilavong	453.5
 NSW	YUEN Edmund - FALKOWSKI Ricardo	449.5
 NSW	FALKOWSKI Ricardo - WANG Louis	429.0
 QLD	NELSON Paul - ANDJELKOVIC Srdjan	209.8